



Getting Started with HFSS: Ultra High Frequency Probe



ANSYS, Inc.
Southpointe
2600 Ansys Drive
Canonsburg, PA 15317
ansysinfo@ansys.com
<https://www.ansys.com>
(T) 724-746-3304
(F) 724-514-9494

Release 2024 R2
July 2024

ANSYS, Inc. and ANSYS
Europe, Ltd. are UL registered
ISO 9001:2015 companies.

Copyright and Trademark Information

© 1986-2024 ANSYS, Inc. Unauthorized use, distribution or duplication is prohibited.

ANSYS, Ansys Workbench, AUTODYN, CFX, FLUENT and any and all ANSYS, Inc. brand, product, service and feature names, logos and slogans are registered trademarks or trademarks of ANSYS, Inc. or its subsidiaries located in the United States or other countries. Icem CFD is a trademark used by ANSYS, Inc. under license. All other brand, product, service and feature names or trademarks are the property of their respective owners. FLEXIm and FLEXnet are trademarks of Flexera Software LLC.

Disclaimer Notice

THIS ANSYS SOFTWARE PRODUCT AND PROGRAM DOCUMENTATION INCLUDE TRADE SECRETS AND ARE CONFIDENTIAL AND PROPRIETARY PRODUCTS OF ANSYS, INC., ITS SUBSIDIARIES, OR LICENSORS. The software products and documentation are furnished by ANSYS, Inc., its subsidiaries, or affiliates under a software license agreement that contains provisions concerning non-disclosure, copying, length and nature of use, compliance with exporting laws, warranties, disclaimers, limitations of liability, and remedies, and other provisions. The software products and documentation may be used, disclosed, transferred, or copied only in accordance with the terms and conditions of that software license agreement.

ANSYS, Inc. and ANSYS Europe, Ltd. are UL registered ISO 9001: 2015 companies.

U.S. Government Rights

For U.S. Government users, except as specifically granted by the ANSYS, Inc. software license agreement, the use, duplication, or disclosure by the United States Government is subject to restrictions stated in the ANSYS, Inc. software license agreement and FAR 12.212 (for non-DOD licenses).

Third-Party Software

See the legal information in the product help files for the complete Legal Notice for Ansys proprietary software and third-party software. If you are unable to access the Legal Notice, please contact ANSYS, Inc.

Conventions Used in this Guide

Please take a moment to review how instructions and other useful information are presented in this documentation.

- Procedures are presented as numbered lists. A single bullet indicates that the procedure has only one step.
- Bold type is used for the following:
 - Keyboard entries that should be typed in their entirety exactly as shown. For example, “**copy file1**” means you must type the word **copy**, then type a space, and then type **file1**.
 - On-screen prompts and messages, names of options and text boxes, and menu commands. Menu commands are often separated by greater than signs (>). For example, “click **HFSS > Excitations > Assign > Wave Port.**”
 - Labeled keys on the computer keyboard. For example, “Press **Enter**” means to press the key labeled **Enter**.
- Italic type is used for the following:
 - Emphasis.
 - The titles of publications.
 - Keyboard entries when a name or a variable must be typed in place of the words in italics. For example, “**copy filename**” means you must type the word **copy**, then type a space, and then type the name of the file.
- The plus sign (+) is used between keyboard keys to indicate that you should press the keys at the same time. For example, “Press Shift+F1” means to press the **Shift** key and, while holding it down, press the **F1** key also. You should always depress the modifier key or keys first (for example, Shift, Ctrl, Alt, or Ctrl+Shift), continue to hold it/them down, and then press the last key in the instruction.

Accessing Commands: *Ribbons*, *menu bars*, and *shortcut menus* are three methods that can be used to see what commands are available in the application.

- The *Ribbon* occupies the rectangular area at the top of the application window and contains multiple tabs. Each tab has relevant commands that are organized, grouped, and labeled. An example of a typical user interaction is as follows:

"Click **Draw > Line**"



This instruction means that you should click the **Line** command on the **Draw** ribbon tab. An image of the command icon, or a partial view of the ribbon, is often included with the instruction.

- The *menu bar* (located above the ribbon) is a group of the main commands of an application arranged by category such File, Edit, View, Project, etc. An example of a typical user interaction is as follows:

"On the **File** menu, click the **Open Examples** command" means you can click the **File** menu and then click **Open Examples** to launch the dialog box.

- Another alternative is to use the *shortcut menu* that appears when you click the right-mouse button. An example of a typical user interaction is as follows:

"Right-click and select **Assign Excitation > Wave Port**" means when you click the right-mouse button with an object face selected, you can execute the excitation commands from the shortcut menu (and the corresponding sub-menus).

Getting Help: Ansys Technical Support

For information about Ansys Technical Support, go to the Ansys corporate Support website, <http://www.ansys.com/Support>. You can also contact your Ansys account manager in order to obtain this information.

All Ansys software files are ASCII text and can be sent conveniently by e-mail. When reporting difficulties, it is extremely helpful to include very specific information about what steps were taken or what stages the simulation reached, including software files as applicable. This allows more rapid and effective debugging.

Help Menu

To access help from the Help menu, click **Help** and select from the menu:

- **[product name] Help** - opens the contents of the help. This help includes the help for the product and its *Getting Started Guides*.
- **[product name] Scripting Help** - opens the contents of the *Scripting Guide*.
- **[product name] Getting Started Guides** - opens a topic that contains links to Getting Started Guides in the help system.

Context-Sensitive Help

To access help from the user interface, press **F1**. The help specific to the active product (design type) opens.

You can press **F1** while the cursor is pointing at a menu command or while a particular dialog box or dialog box tab is open. In this case, the help page associated with the command or open dialog box is displayed automatically.

Table of Contents

Table of Contents	Contents-1
1 - Introduction	1-1
Sample Project: UHF Probe	1-1
2 - Set Up the Project	2-1
Launch Ansys Electronics Desktop	2-1
Set General Options	2-2
Insert HFSS Design	2-3
Enable Legacy View Orientations	2-5
Set Units and Solution Type	2-7
3 - Create the 3D Model	3-1
Select Default Material	3-1
Create Outside Tube	3-2
Create Inside Tube	3-6
Create Element 1	3-9
Unite Element 1 and Boom	3-11
Create Center Pin	3-13
Create Element 2	3-14
Create Grounding Pin	3-15
Unite Element 2 and Pins	3-17
Create Port Circle	3-18
Create Open Region	3-19
Assign Excitation	3-21
Verify Radiation Setup	3-23
Refine Radiation Boundary Mesh	3-24
4 - Analyze the Model	4-1
Add Solution Setup	4-1
Add Frequency Sweep	4-2
Validate and Run Simulation	4-3

View Solution Data	4-3
Terminal S-Parameter vs. Frequency Plot	4-9
Overlay Far Field Gain Plots	4-11
5 - Optionally, Restore Current View Orientations	5-1

1 - Introduction

This document includes instructions to create an ultrahigh frequency probe model, set up a terminal network analysis, run the simulation, and evaluate the results. By following this guide, you will learn how to perform the following tasks in the *Ansys Electronics Desktop* application:

- Customize the program options
- Build a model by drawing basic geometric shapes
- Perform Boolean operations:
 - Unite multiple objects into a single one
 - Subtract one or more objects from another object
- Assign boundaries and excitations
- Create an infinite ground plane
- Create an open region and radiation setup
- Add mesh size controls
- Define a frequency sweep
- Validate the design and run the analysis
- View solution data
- Create an S-parameter vs. frequency plot
- Create a far field gain plot

Sample Project: UHF Probe

An ultrahigh frequency (UHF) probe is a dipole antenna that operates in the ultrahigh frequency range. The model you will build and solve is pictured below:

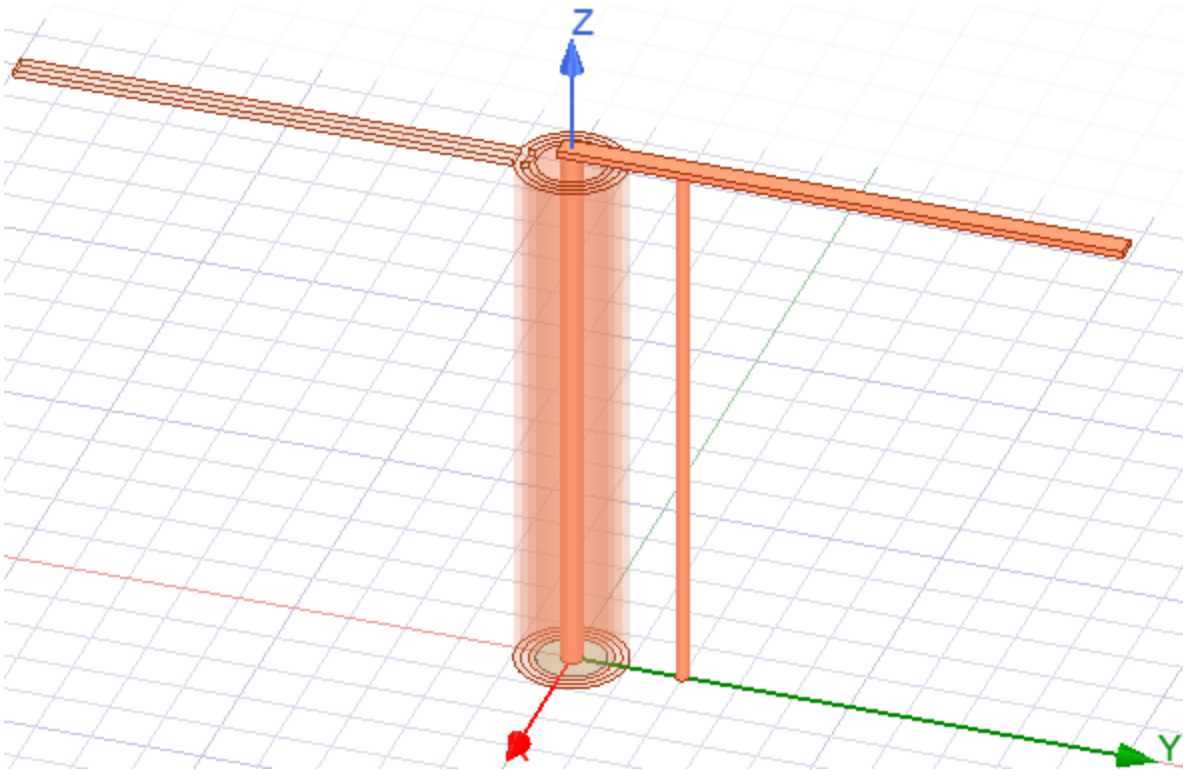

Figure 1-1: UHF Probe Model

2 - Set Up the Project

This chapter contains the following topics:

- Launch Ansys Electronics Desktop
- Set General Options
- Insert HFSS Design
- Enable Legacy View Orientations
- Set Model Units
- Set Solution Type

Launch Ansys Electronics Desktop

For convenience, a shortcut to the Ansys Electronics Desktop (EDT) application is placed on your desktop during program installation. Optionally, you may want to pin the shortcut to your Windows Start Menu too. Before proceeding to the next topic, launch EDT and add a blank project, as follows:



1. Double-click the **EDT Ansys Electronics Desktop** shortcut on your desktop (or the same shortcut on your Start Menu).

The Ansys Electronics Desktop application opens:

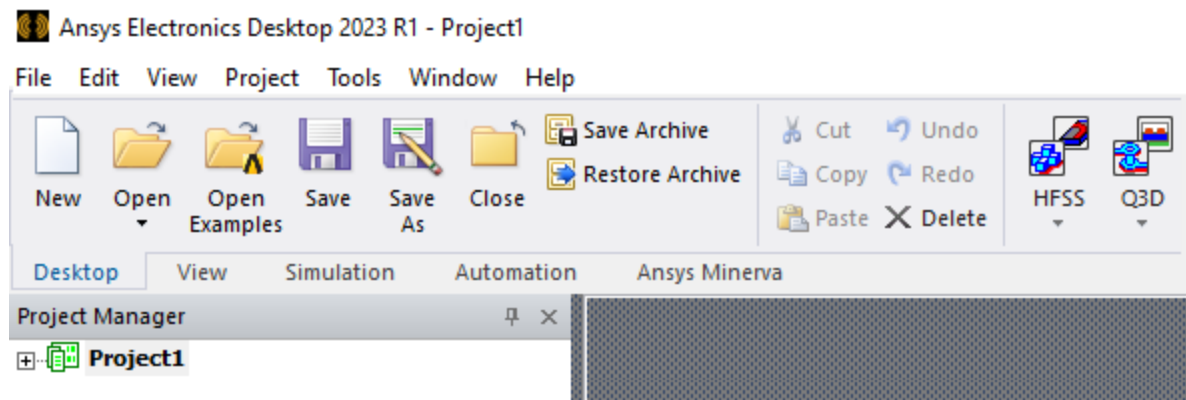



Figure 2-1: Ansys EDT Application Launched

2. If a project is not listed at the top of the Project Manager, click  **New** on the **Desktop** ribbon tab to include one. If the Project Manager window does not appear after launching the application, go to the **View** menu and select the **Project Manager** option.

Note:

Normally, a new, project is added automatically when you launch EDT. If you had the application open already and closed the model you were working on, you will have to add a new project manually.

Set General Options

Verify the options under the **Tools** menu as follows:

1. On the **Desktop** ribbon tab, click  **General Options**.

The *Options* dialog box appears.

2. On the left side of the dialog box, expand the **HFSS** branch, select **Boundary Assignment**, and insure that all options in this group are selected:

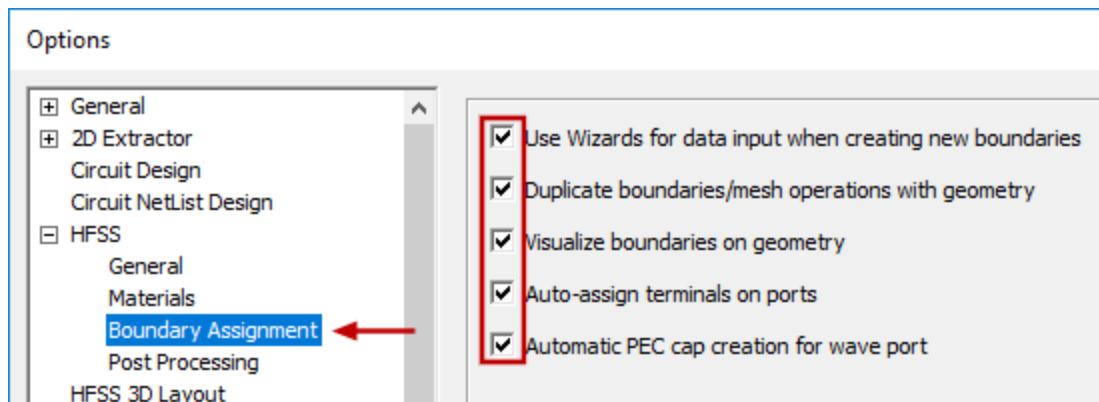

Figure 2-2: HFSS Boundary Assignment Options

3. Expand the **3D Modeler** branch, select **Drawing**, and ensure that the following two options are selected:
 - **Automatically cover closed Polyline**
 - **Edit property of new primitives**

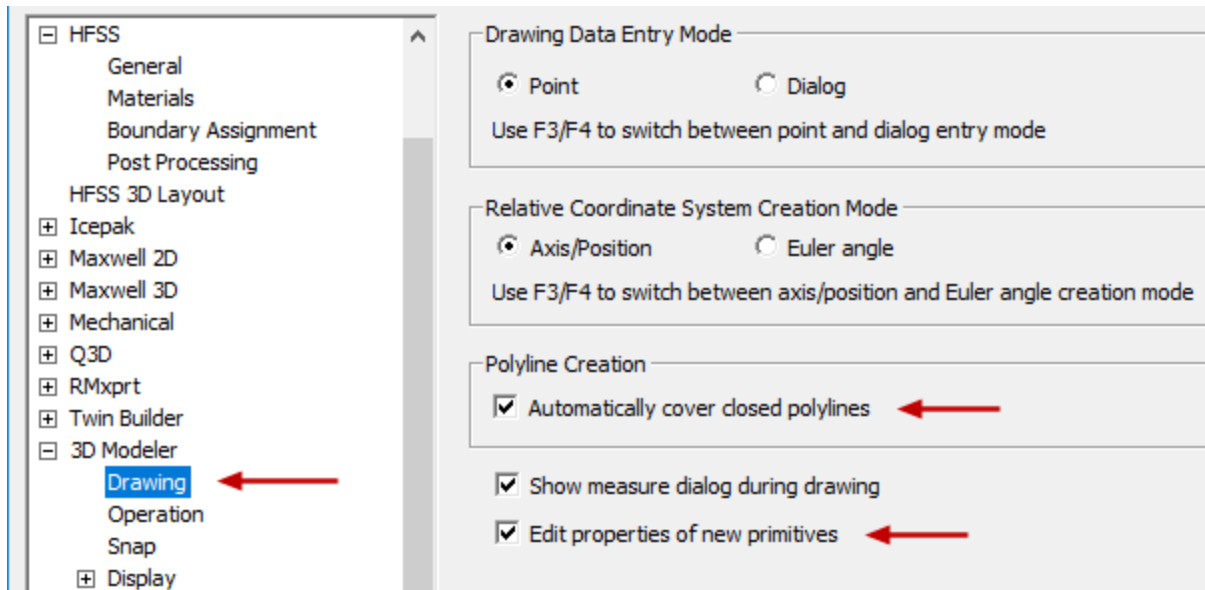

Figure 2-3: 3D Modeler Drawing Options

Note:

The *Edit properties of new primitives* option causes a *Properties* dialog box to appear when you create a new object in the Modeler.

4. Click **OK**.

Insert HFSS Design

Insert an HFSS design and save your project in a folder of your choice, specifying an appropriate file name in the process.

1. On the **Desktop** ribbon tab, click **HFSS** (*Insert HFSS design*). You do not have to access the *HFSS* drop-down menu since the default action is to insert a regular HFSS design type.
2. The *Modeler* window appears on the desktop, the ribbon advances to the *Draw* tab, and *HFSSDesignx* appears under *Projectx* in the Project Manager:

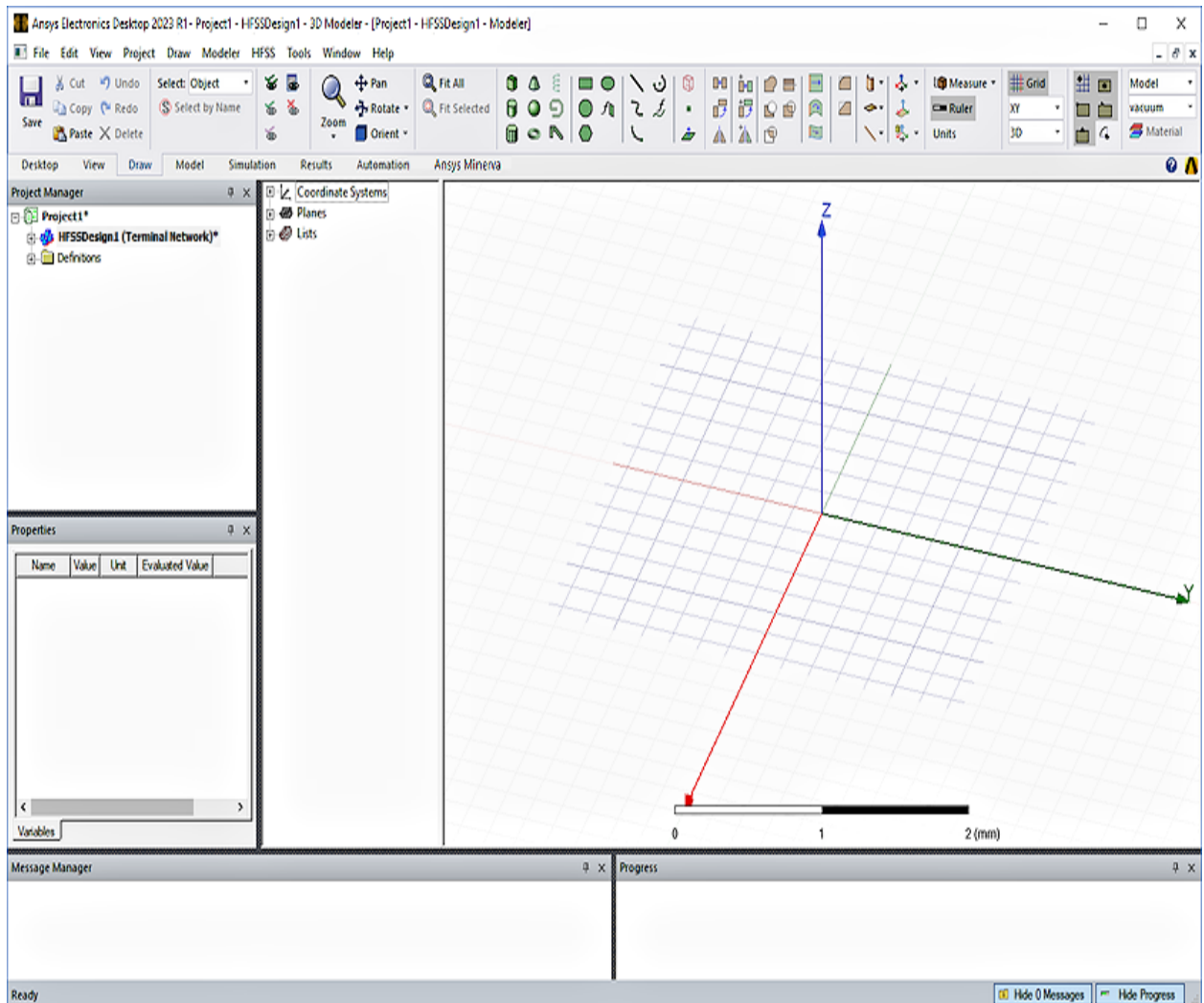





Figure 2-4: HFSS Design Added to the Project

Note:

Inclusion of the HFSS design modifies the project. An asterisk appears after the project name to indicate that there are unsaved changes. Also, *Terminal Network* is the default solution type (appended to the design name), unless a user has previously saved different default options. A terminal network analysis is the correct option for this exercise. You will verify the solution type settings in a later step.

3. Optionally, to change the Modeler window's axis display style, click **View > Coordinate System** from the menu bar and select the desired option. (Images in this guide are based on the *Large* axis scheme.)

4. Similarly, click **View > Grid Settings** from the menu bar to adjust the grid settings (type, style, density/increments, and visibility). Or, click  **Grid** on the **Draw** ribbon tab to toggle its visibility. (Default grid settings are used for the images in this guide.)
5. You can also toggle the *Ruler* visibility by clicking  **Ruler** on the **Draw** ribbon tab. (The ruler is hidden for the images in this guide.)
6. In the **Desktop** ribbon tab, click  **Save As**.

The *Save As* dialog box appears.

7. Browse to and select a working folder of your choice where you want to store the project files. You can also create a new folder from this dialog box.
8. Type **UHF_Probe** in the **File name** text box and then click **Save**.

The file *UHF_Probe.aedt* is saved to your default projects folder or to whichever alternative location you may have chosen. Notice that the project name at the top of the Project Manager has been updated.

Enable Legacy View Orientations

This getting started guide was created based on standard view orientations that were in effect for version 2023 R2 and earlier of the Ansys Electronics Desktop application. For consistency between your experience and the views and instructions contained in this guide, select the *Enable Legacy View Orientation* option in the 3D UI Options dialog box, as follows:

1. From the menu bar, click **View > Options**.
The *3D UI Options* dialog box appears.
2. Select **Enable Legacy View Orientation**:

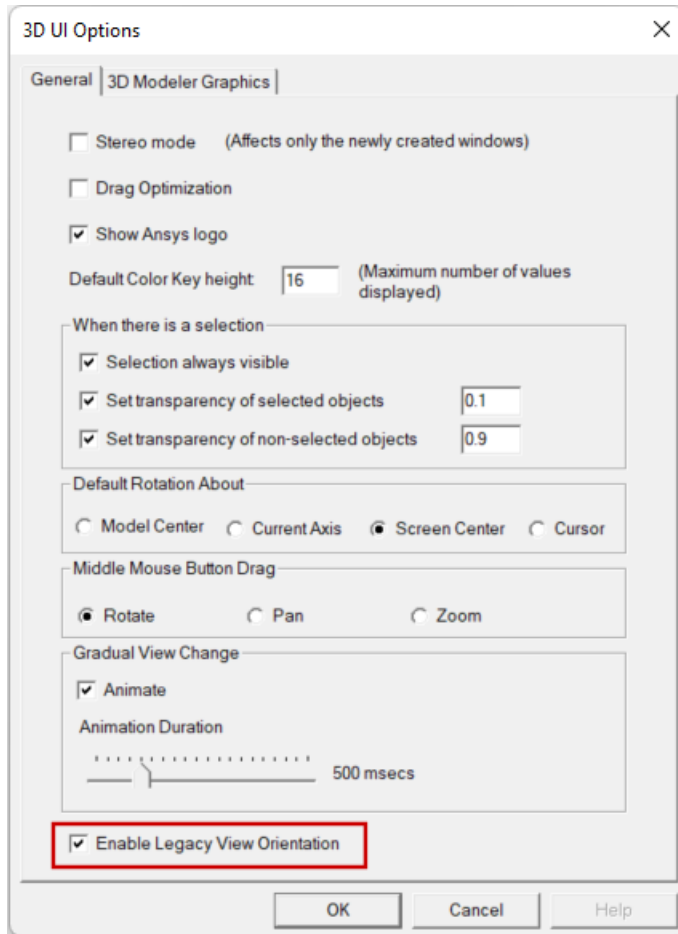

3. Click **OK**.

Changing the view orientation option does not change the model viewpoint that was in effect at the time.

4. On the **Draw** ribbon tab, click  **Orient** to change to the *Trimetric* view, which is the default legacy view orientation.

You do not have to select *Trimetric* from the *Orient* drop-down menu. The default view appears when you click *Orient*.

Although this option can only be accessed once a design is added to a project, it is a global option. Your choice is retained for all future program sessions, projects, and design types that use the 3D Modeler or that produce 3D plots of results.

At the end of this guide, you will be prompted to clear the *Enable Legacy View Orientation* option, if you prefer to use the view orientation scheme implemented for 2024 R1 and newer versions going forward.

For a comparison of the legacy and current view orientations, search for "*View Options: 3D UI Options*" in the HFSS help. Additionally, views associated with **Alt + double-click** zones have

been redefined. The current orientations are shown in the help topic, "*Changing the Model View with Alt+Double-Click Areas.*"

Set Units and Solution Type

Define the units for the geometric model as follows:

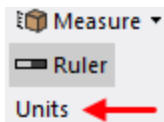

1. On the **Draw** ribbon tab, click **Units**. (There's no icon associated with this command.)

The *Set Model Units and Max Extent* dialog box appears.

2. Select **in** (inches) from the **Select units** drop-down menu.

Keep **Rescale to new units** cleared and keep the default **Max model extent (E)** setting of **10000**.

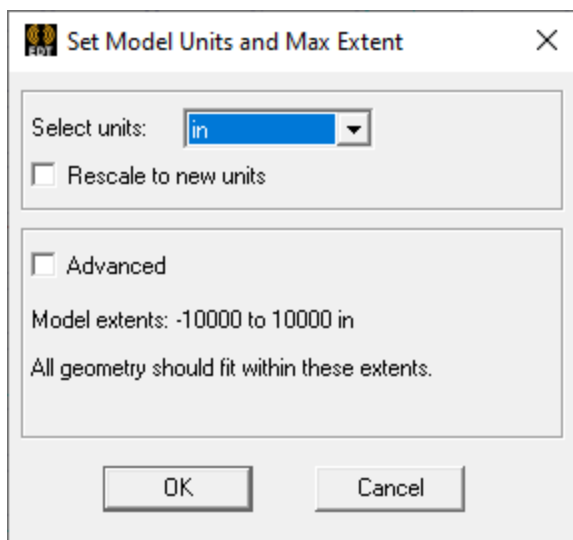

Figure 2-5: Choosing the Length Unit

3. Click **OK**.

Verify the solution type and change it if necessary:

4. Using the menu bar, click **HFSS > Solution Type**.

The *Solution Type* dialog box appears.

5. Ensure that the solution type and options are set as shown in the following image:

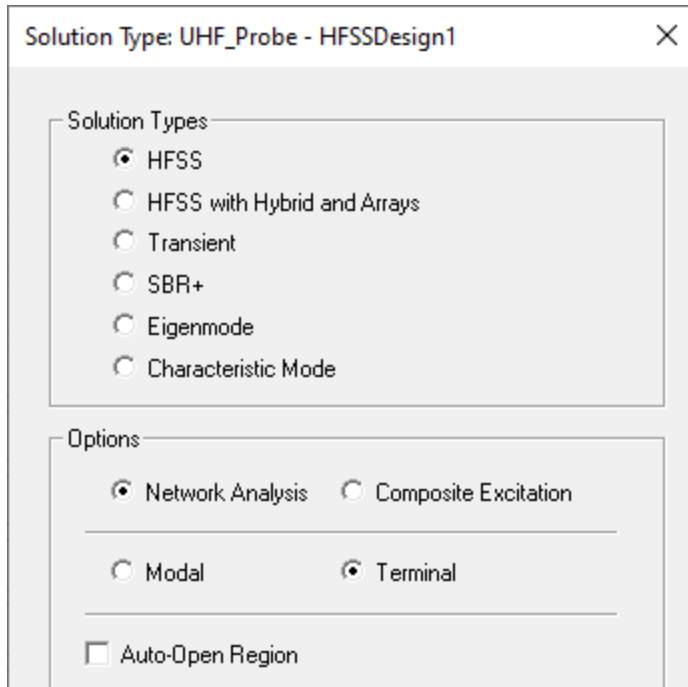

Figure 2-6: Solution Type Settings

6. Click **OK**.

Note:

Terminal solutions calculate terminal-based S-parameters of multi-conductor transmission line ports. The S-matrix solutions are expressed in terms of terminal voltages and currents.

3 - Create the 3D Model

This chapter contains the following topics:

- Select Default Material
- Create Outside Tube
- Create Inside Tube
- Create Element 1
- Unite Element 1 and Boom
- Create Center Pin
- Create Element 2
- Create Grounding Pin
- Unite Element 2 and Pins
- Create Port Circle
- Create Open Region
- Assign Excitation
- Edit Radiation Setup
- Refine Radiation Boundary Mesh

Select Default Material

All of the solid objects that comprise the UHF probe, with the exception of the open region, are made of copper. To streamline the construction process, you will first select copper as the default material for new objects, as follows:

1. On the Draw ribbon tab (at the far right end), choose **Select** from the **Default material** drop-down menu.

The *Select Definition* dialog box appears.

2. Type **cop** in the **Search by Name** text box.

The material **copper** is selected from the list of library materials:

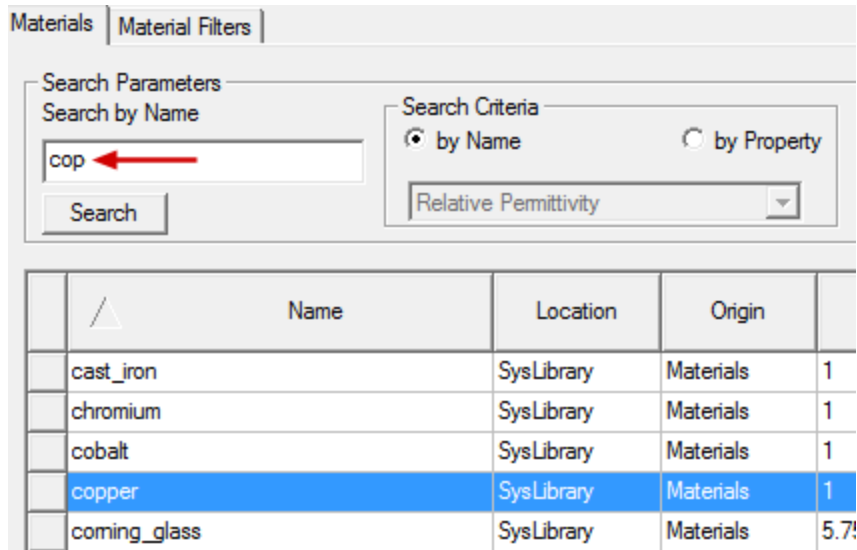



Figure 3-1: Selecting the Default Material (copper)

3. Click **OK** to complete the selection.

Create Outside Tube

The main *Boom* of the UHF probe consists of two concentric tubes and a central conducting pin. In this procedure, you will create the outside tube by drawing two concentric cylinders and subtracting the inner cylinder from the outer one.

1. On the **Draw** ribbon tab, click  **Draw cylinder**.
2. Press **F3** to ensure that you are in the *Point entry mode*.

A black diamond indicates grid snapping points as you move the cursor.

3. Click at the global coordinate system **origin** to define the center of the cylinder's base circle.
4. Click at an arbitrary point to set the cylinder's radius (you will adjust the value later).
5. Move the cursor upward an arbitrary distance and click to set the initial cylinder height.

The *Properties* dialog box appears.

6. Under the **Command** tab of the *Properties* dialog box, edit the **Radius** and **Height**, specifying the *Values* shown in the following figure:

Command		Attribute		
Name	Value	Unit	Evaluated Value	
Command	CreateCylinder			
Coordinate System	Global			
Center Position	0,0,0	in	0in, 0in, 0in	
Axis	Z			
Radius	0.5	in	0.5in	
Height	5	in	5in	
Number of Segments	0		0	

Figure 3-2: Boom, Outer Tube OD Properties – Command Tab

Keep the *Properties* dialog box open.

7. On the **Attribute** tab of the *Properties* dialog box, make the following changes:
 - a. Change the **Name** to **Boom**.
 - b. Select the **Material Appearance** option.
8. Click **OK** and then click in the Modeler window's background area to clear the selection.

Notice that the predefined color of the copper material, as defined in the library, has been applied to the object:

9. On the **Draw** ribbon tab, click  **Fit All** (or press **Ctrl+D**) to fit the model to the viewing area.

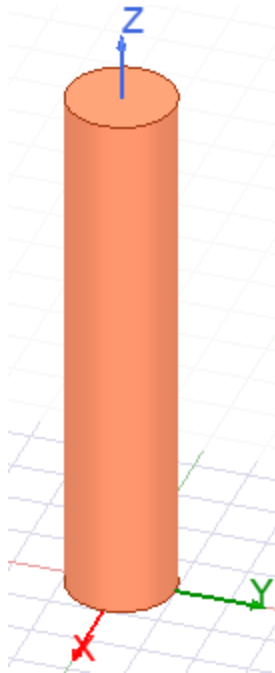

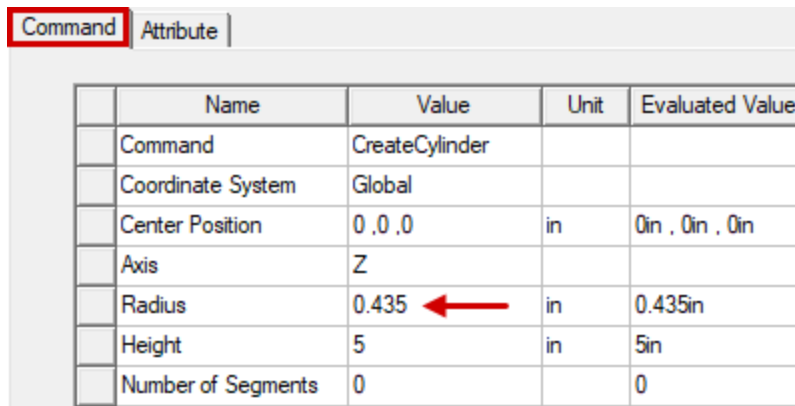



Figure 3-3: Outermost Cylinder of the Boom

10. Again, on the **Draw** ribbon tab, click  **Draw cylinder**.
11. Click at the global coordinate system **origin**. A large solid dot indicates the snapping point, which is also the center of the previous cylinder's base circle.
12. Click at an arbitrary point to set the cylinder's initial radius.
13. Click at the center of the previous cylinder's top face to set the height. A solid dot again indicates the snapping point (though the dot appear off center, at the arbitrary radius).
14. In the **Command** tab of the *Properties* dialog box, change the **Radius** value to **0.435 in**, and ensure that the other properties are as shown in the following figure:



	Name	Value	Unit	Evaluated Value
	Command	CreateCylinder		
	Coordinate System	Global		
	Center Position	0 , 0 , 0	in	0in , 0in , 0in
	Axis	Z		
	Radius	0.435	in	0.435in
	Height	5	in	5in
	Number of Segments	0		0

Figure 3-4: Boom, Outer Tube ID Properties – Command Tab

15. Click **OK**. You do not need to change any of the cylinder attributes.
16. Clear the current selection.
17. Under *Model > Solids > copper* in the History Tree, select the objects **Boom** and **Cylinder1** (in that specific order).
18. On the **Draw** ribbon tab, click  **Subtract**.
19. In the *Subtract* dialog box that appears, ensure that **Boom** is listed under *Blank Parts* and **Cylinder1** under **Tool Parts**. Also ensure that **Clone tool objects before operation** is **not** selected:

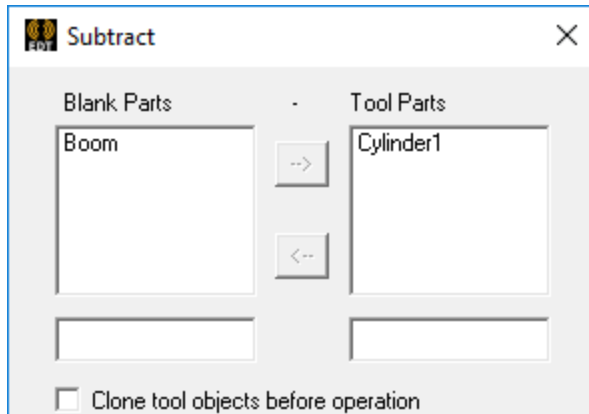

Figure 3-5: Subtracting *Cylinder1* from *Boom*

Note:

The selection order determines which part is the *Blank* (first selected) and which is the *Tool*. However, you can move objects from either list to the other using the provided arrow keys.

Warning:

If you use the **S** *Select by Name* command on the *Draw* ribbon tab to select multiple objects in the model (rather than selecting them graphically or from the History Tree), the behavior is different. The order that you select items within the *Select by Name* dialog box **has no effect** on the outcome of the subsequent operation. In this case, the first of the selected objects in the dialog box, *as listed alphabetically*, is the *Blank* part, regardless of the selection order. If you wish to use this alternative selection method, select the object that is to be the *Blank* part separately (*before* accessing the *Select by Name* dialog box to choose the remaining items).

20. Click **OK**.
21. Clear the selection.

The outer tube of the *Boom* should look like the following figure:

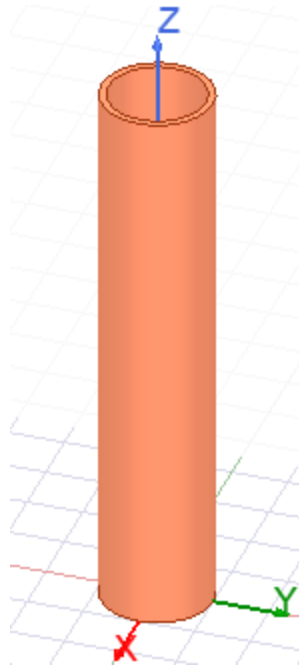

Figure 3-6: Outside Tube of Boom Created

Create Inside Tube

The UHF probe has a double-walled boom. In this procedure you will make a smaller tube positioned inside of the tube you just completed. There is a small gap between the two tubes. Rather than draw two cylinders and perform a subtraction, you will copy the existing tube (*Boom*) and paste a duplicate of it into the model. Then, you will edit the radii of the two cylinders (ID and OD) to create the inside tube of the *Boom* assembly.

1. Under *Model > Solids > copper* in the History Tree, right-click **Boom** and choose **Edit > Copy** from the shortcut menu.
2. Right-click anywhere in the modeler window and choose **Edit > Paste**.

A duplicate object (*Boom1*) appears in the History Tree.

3. Under *...Boom1 > Subtract > Cylinder2* in the History Tree, select **CreateCylinder**.

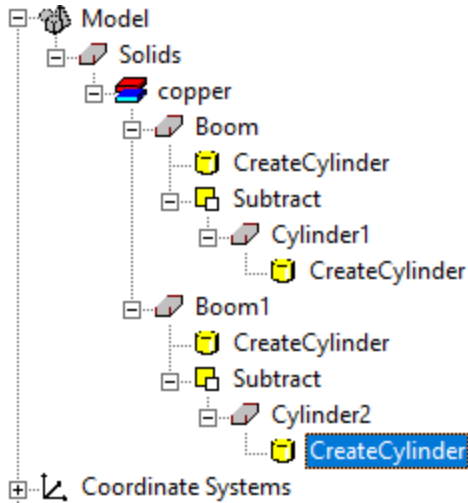

Figure 3-7: Selecting Cylinder for Inside Tube ID

The *Command* tab for this cylinder appears in the docked *Properties* window.:

Note:
The *Properties* window is docked under the *Project Manager* window by default.

4. Change the **Radius** value from 0.435 to **0.31 in** and press **Enter**:

Name	Value	Unit	Evaluated Value
Command	CreateCylinder		
Coordinate System	Global		
Center Position	0,0,0	in	0in, 0in, 0in
Axis	Z		
Radius	0.31	in	0.31in
Height	5	in	5in
Number of Segments	0		0

Figure 3-8: Boom, Inner Tube ID Properties

5. Immediately below ...*Boom1* in the History Tree, select **CreateCylinder**.

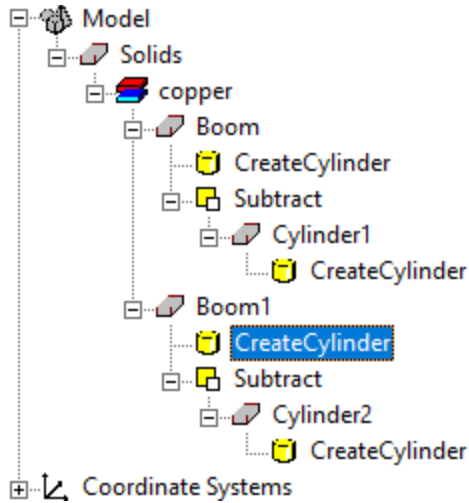

Figure 3-9: Selecting Cylinder for Inside Tube OD

- In the docked *Properties* window, change the **Radius** value from 0.5 to **0.37** and press **Enter**:

Name	Value	Unit	Evaluated Value
Command	CreateCylinder		
Coordinate System	Global		
Center Position	0,0,0	in	0in, 0in, 0in
Axis	Z		
Radius	0.37	in	0.37in
Height	5	in	5in
Number of Segments	0		0

Figure 3-10: Boom, Inner Tube OD Properties

- Clear the selection.

The model should resemble the following figure:

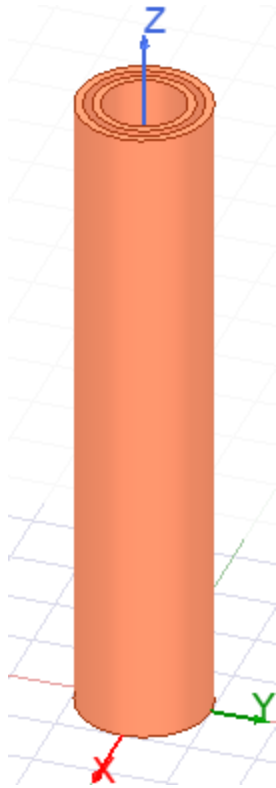

Figure 3-11: Concentric Boom Tubes

8. It's a good time to  **Save** the project.

Note:

This command is available from any ribbon tab and from the **File** menu.

Create Element 1

The structure you are drawing in this project is a dipole antenna, which includes two conducting elements, one connected to the boom and one connected to a center pin and a grounding pin. The elements both have a solid rectangular cross section. Draw the first element (the one connected to the boom) as follows:

1. On the **Draw** ribbon tab, click  **Draw box**.
2. Click three arbitrary points in the drawing area to draw a random box.

The *Properties* dialog box appears after the third click.

3. In the **Command** tab of the *Properties* dialog box, specify the settings shown in the following image:

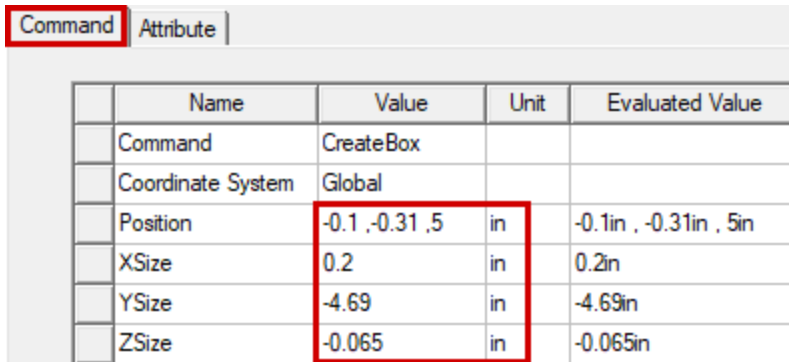

	Name	Value	Unit	Evaluated Value
	Command	CreateBox		
	Coordinate System	Global		
	Position	-0.1 , -0.31 , .5	in	-0.1in , -0.31in , .5in
	XSize	0.2	in	0.2in
	YSize	-4.69	in	-4.69in
	ZSize	-0.065	in	-0.065in

Figure 3-12: Element 1 Properties – Command Tab

Keep the dialog box open.

4. On the **Attribute** tab of the *Properties* dialog box, make the following changes:
 - a. Change the **Name** to **Element_1**.
 - b. Select the **Material Appearance** option.
5. Click **OK**.
6. Press **Ctrl+D** to fit the view and clear the selection.

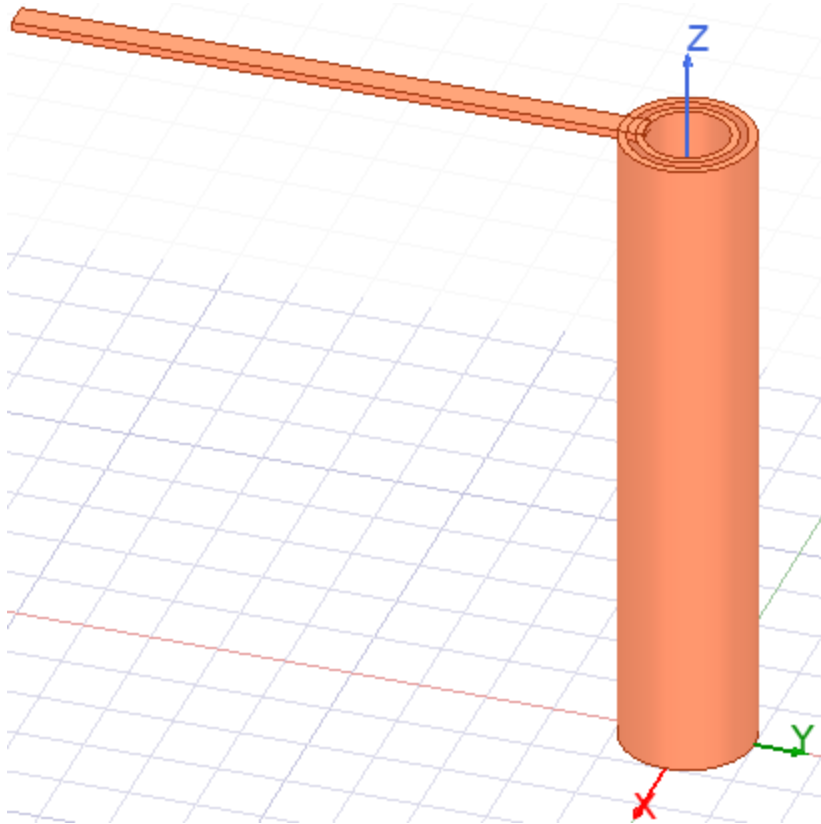

Figure 3-13: *Element_1* Created

Unite Element 1 and Boom

You can now select all of the conductors drawn thus far to connect them together. As before, the selection order is important.

1. Under *Model > Solids > copper* in the History Tree, select **Element_1**, **Boom**, and **Boom1** (in that specific order).

Note:

The object selected first determines attributes of the united object (name, material, appearance, and more).

Warning:

If you use the **S** *Select by Name* command on the *Draw* ribbon tab to select multiple objects in the model (rather than selecting them graphically or from the History Tree), the behavior is different. The order that you select items within the *Select by Name* dialog box **has no effect** on the outcome of the subsequent operation. In this case, the first of the selected objects in the dialog box, *as listed alphabetically*, determines the attributes of the united object, regardless of the selection order. If you wish to use this alternative method, select the object separately that is to determine the attributes of the united object (*before* accessing the *Select by Name* dialog box to choose the remaining items).

2. On the **Draw** ribbon tab, click  **Unite**.

Note:

You can also right click in the Modeler window and choose **Edit > Boolean > Unite** from the shortcut menu.

The selected objects are combined into a single part named *Element_1*:

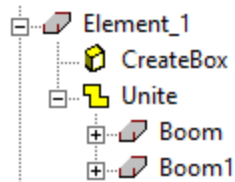

Figure 3-14: History Tree – Element_1 Assembly United

3. Clear the selection.

You can also tell that the objects have been merged into one because short segments of the tube ODs and outer tube ID are missing where the objects intersect:

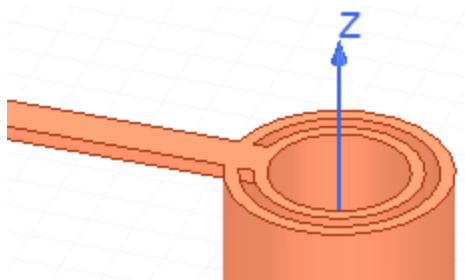

Figure 3-15: Element_1 Assembly United

Create Center Pin

1. Draw a **Cylinder** starting at the global **origin**, with **Radius = 0.1 inch** and **Height = 5.1 inches**:

	Name	Value	Unit	Evaluated Value
Command	Command	CreateCylinder		
Coordinate System	Coordinate System	Global		
Center Position	Center Position	0,0,0	in	0in, 0in, 0in
Axis	Axis	Z		
Radius	Radius	0.1	in	0.1in
Height	Height	5.1	in	5.1in
Number of Segments	Number of Segments	0		0

Figure 3-16: Center Pin Properties – Command Tab

2. In the **Attribute** tab of the *Properties* dialog box, make the following changes:
 - a. Change the Name to **Center_Pin**.
 - b. Select the **Material Appearance** option.

Note:

It is not really essential to edit this cylinder's *Attributes*. When united with *Element 2* in a later step, the center pin will assume the name, material, and appearance properties of that object. However, changing the name now makes identifying the correct objects easier, and the other option causes the copper appearance settings to be applied immediately.

3. Click **OK**.

With the center pin still selected, the model appearance should be as shown below:

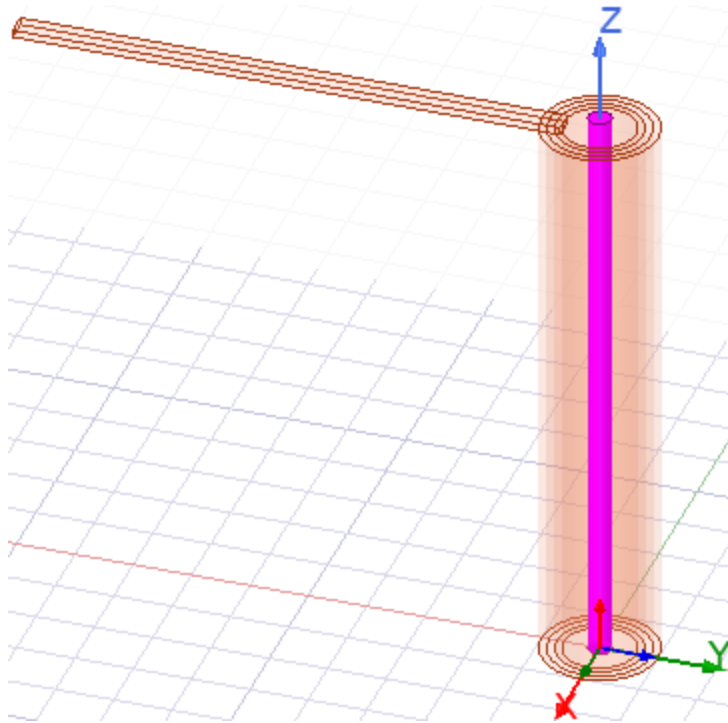

Figure 3-17: Center Pin Created

4. Clear the selection before proceeding to the next topic.

Create Element 2

1. Draw another arbitrary **Box**, as you did for Element 1, and edit the settings in the **Command** tab of the *Properties* dialog box, as shown in the following figure:

Command		Attribute		
Name	Value	Unit	Evaluated Value	
Command	CreateBox			
Coordinate System	Global			
Position	-0.1, -0.1, 5.1	in	-0.1in, -0.1in, 5.1in	
XSize	0.2	in	0.2in	
YSize	5.1	in	5.1in	
ZSize	0.065	in	0.065in	

Figure 3-18: Element 2 Properties – *Command* Tab

2. On the **Attribute** tab of the *Properties* dialog box, make the following changes:

- a. Change the **Name** to **Element_2**.
 - b. Select the **Material Appearance** option.
3. Click **OK**.
 4. Press **Ctrl+D** to fit the view and clear the selection.

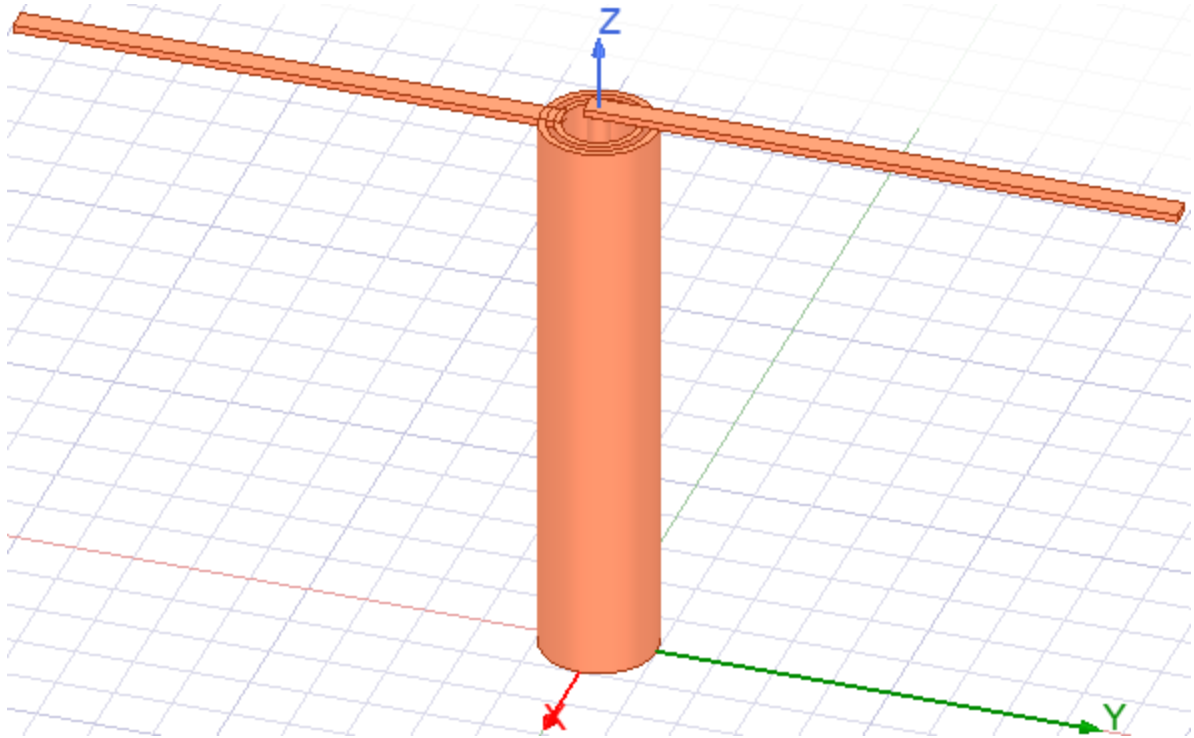

Figure 3-19: *Element_2* Created

Create Grounding Pin

The grounding pin is similar to the center pin. Therefore, you will copy the center pin and edit the properties of the copy that you paste into the model.

1. Under *Model > Solids > copper* in the History Tree, right-click **Center_Pin** and choose **Edit > Copy** from the shortcut menu.
2. Right-click in the Modeler window and choose **Edit > Paste**.

Center_Pin1 appears in the History Tree and its *Command* and *Attribute* settings appear in the docked *Properties* window.

3. In the **Command** tab of the docked Properties window, edit the settings as shown in the following figure:

Name	Value	Unit	Evaluated Value
Command	CreateCylinder		
Coordinate System	Global		
Center Position	0,1,0	in	0in, 1in, 0in
Axis	Z		
Radius	0.0625	in	0.0625in
Height	5.1	in	5.1in
Number of Segments	0		0

Figure 3-20: Grounding Pin Properties – Command Tab

4. In the **Attribute** tab, change the **Name** to **Ground_Pin** and press **Enter**.
5. Clear the selection.

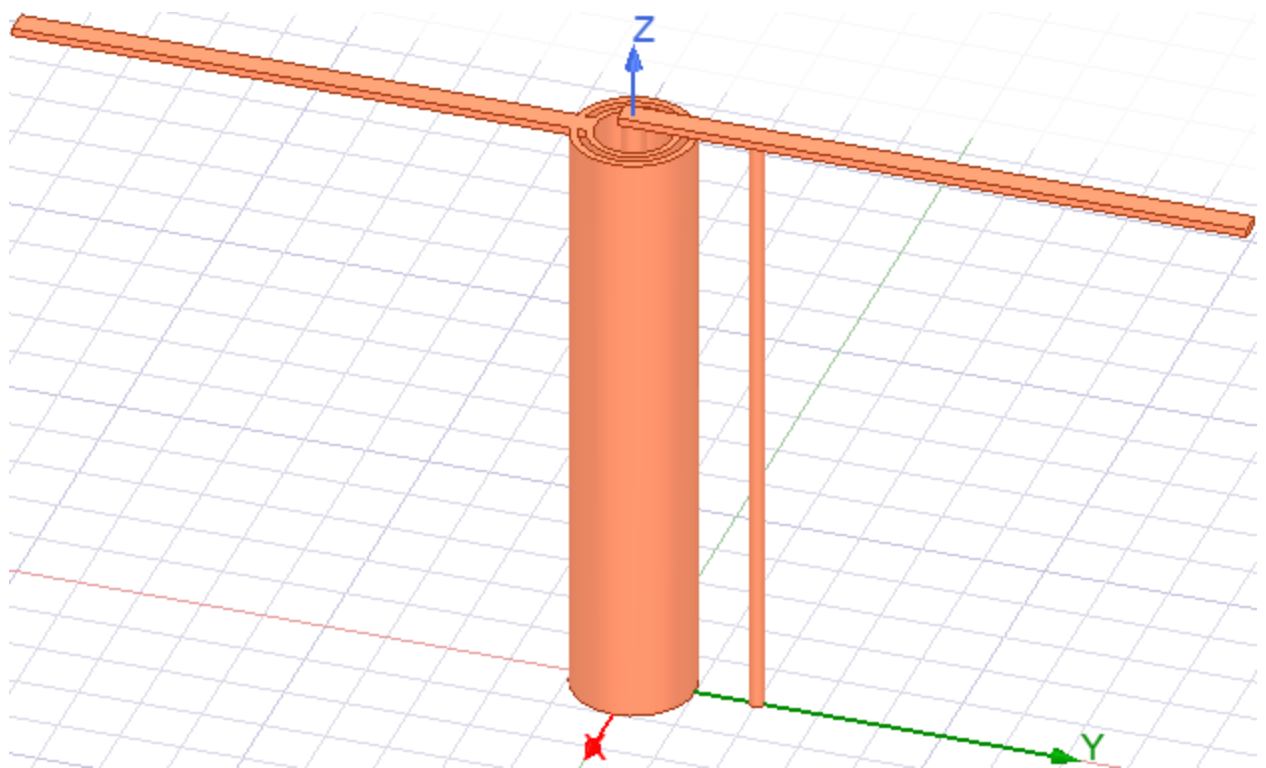



Figure 3-21: Ground_Pin Created

Unite Element 2 and Pins

Unite the second element, center pin, and the grounding pin, keeping *Element_2* as the name of the united object.

1. Under *Model > Solids > copper* in the History Tree, select the objects named **Element_2**, **Center_Pin**, and **Ground_Pin** (in that specific order).
2. On the **Draw** ribbon tab, click  **Unite**.

The 3 items are now united and appear as *Element_2* in the History Tree:

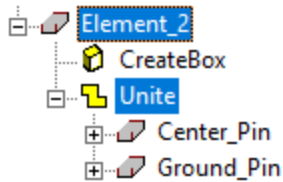

Figure 3-22: History Tree – Element_2 Assembly United

3. Clear the selection.

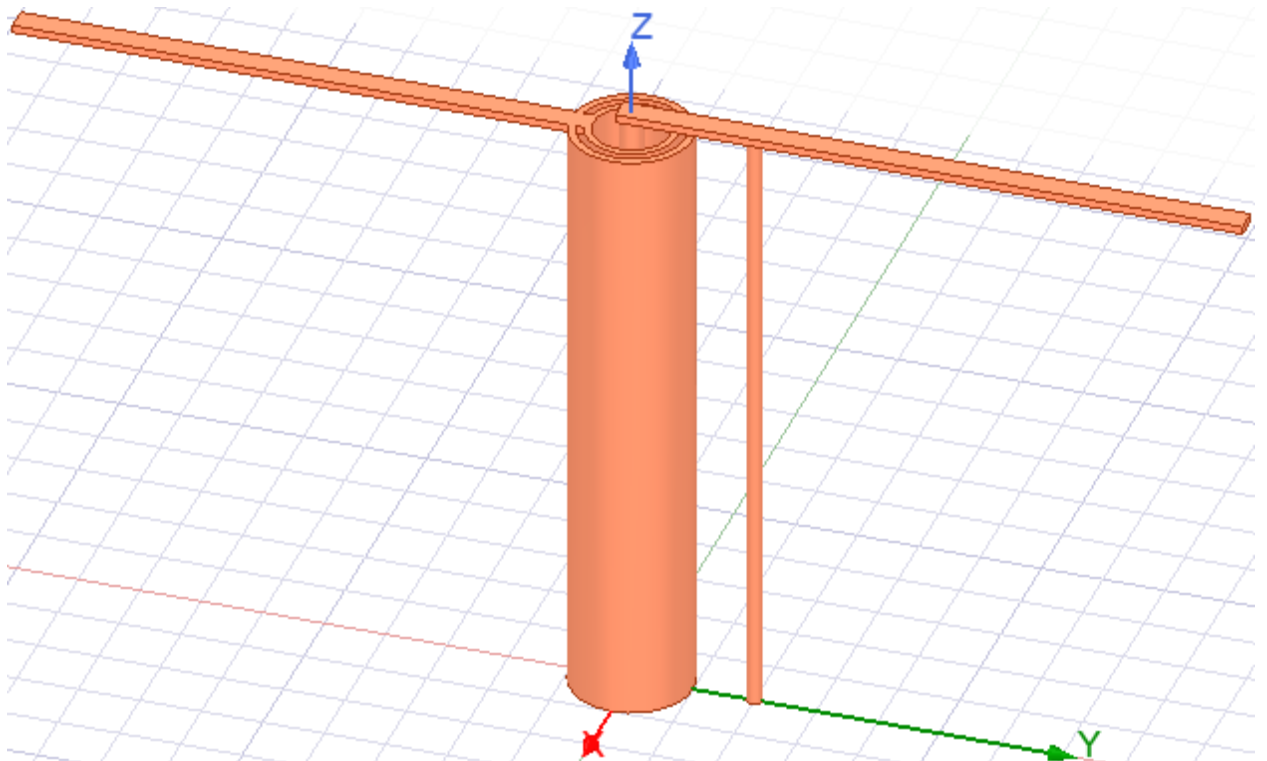



Figure 3-23: *Element_2* Assembly United

4.  Save the project.

Create Port Circle

You will draw a circle at the base of the boom, which will be a sheet object to which you will later assign a wave port excitation.

1. On the **Draw** ribbon tab, click  **Draw circle**.
2. Use the coordinate entry text boxes in the Status Bar to specify the following coordinates:
 - a. For the center position: **X = 0**, **Y = 0**, and **Z = 0**. Press **Enter**.
 - b. For the radius: **dX = 0.31**, **dY = 0**, and **dZ = 0**. Press **Enter**.

The *Properties* dialog box appears.

3. In the **Attribute** tab of the *Properties* dialog box, change the **Name** to **P1**.
4. Click **OK**.

With the *P1* circle still selected, the model looks like the following figure:

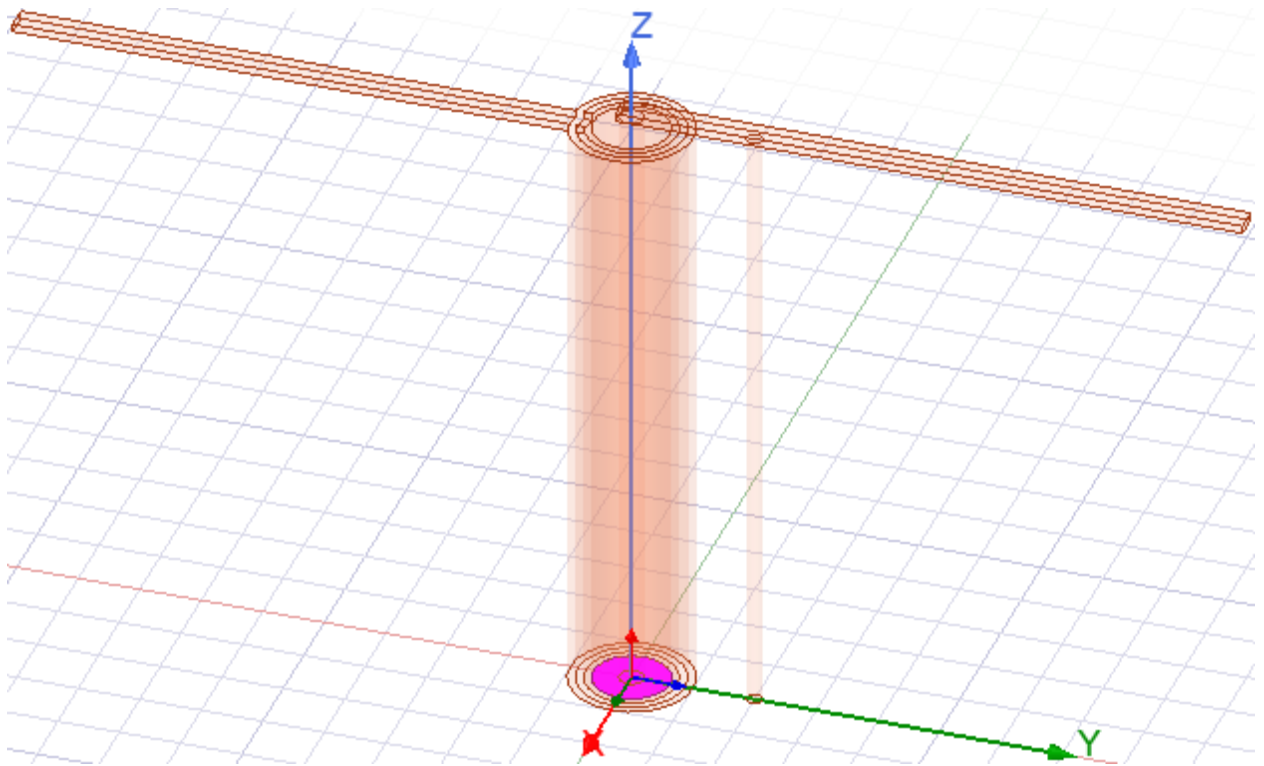

Figure 3-24: Circle P1 Added

5. Clear the selection.

Create Open Region

An open region is a volume surrounding an open model (such as an antenna) in which the near fields are calculated. The region's outside faces have a radiation, FE-BI, or PML boundary applied, and these boundaries absorb the outgoing electromagnetic waves, thus terminating the model. The default material for the open region is vacuum, which is also suitable for determining the behavior of the fields in air (the difference in field behavior between air and vacuum is insignificant).

You will use the *Create Open Region* command to automate the process of creating the region, applying the boundary condition, and creating default far field setups for post processing. In addition, an infinite ground plane can be created at the bottom of the model (along the global XY plane).

The open region is sized automatically to provide an appropriate distance (padding) between the model and the boundaries. The padding distance is based on the solution frequency.

1. Using the menu bar, click **HFSS > Model > Create Open Region**.
2. In the *Create Open Region* dialog box that appears, specify the following settings:
 - a. **Operating Frequency = 0.55 GHz**.
 - b. Select the **Apply infinite ground plane at** option and choose the **NegZ** direction.

This vector indicates on which side of the model the infinite ground plane is placed. The plane is normal to the specified vector and is placed at the elevation of the outermost face of the model in the specified direction. For this model, the bottommost (-Z) face lies on the global XY plane. Therefore, the infinite ground plane happens to lie along the global XY plane, and the open region terminates at this same plane. However, it is not necessary for the outermost model face to correspond to a global plane. The infinite ground plane and open region termination occur at the outermost face of the model in any of the specified six directions.

- c. Ensure that the **Radiation** option is selected under *Boundary*.
3. Click **OK**.

The open region is named *RadiatingSurface*, which appears under *Model > Solids > vacuum* in the History Tree:

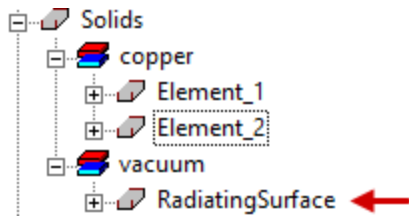

Figure 3-25: Open Region (*RadiationSurface*) Added to History Tree

In addition, infinite ground plane and radiation boundaries appear under *Boundaries* in the Project Manager. They are named *Open_InfiniteGnd1* and *Open1*, respectively:

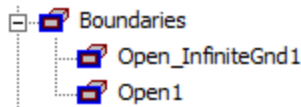

Figure 3-26: Open Region Boundaries Listed in Project Manager

Note:

You can select these Project Manager entries to see a visualization of the boundary conditions on the model.

Finally, three default far field setups appear under *Radiation* in the Project Manager:

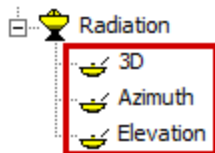

Figure 3-27: Default Far Field Setups

4. Press **Ctrl+D** to fit the open region to the display area.

The open region is displayed in wireframe mode by default.

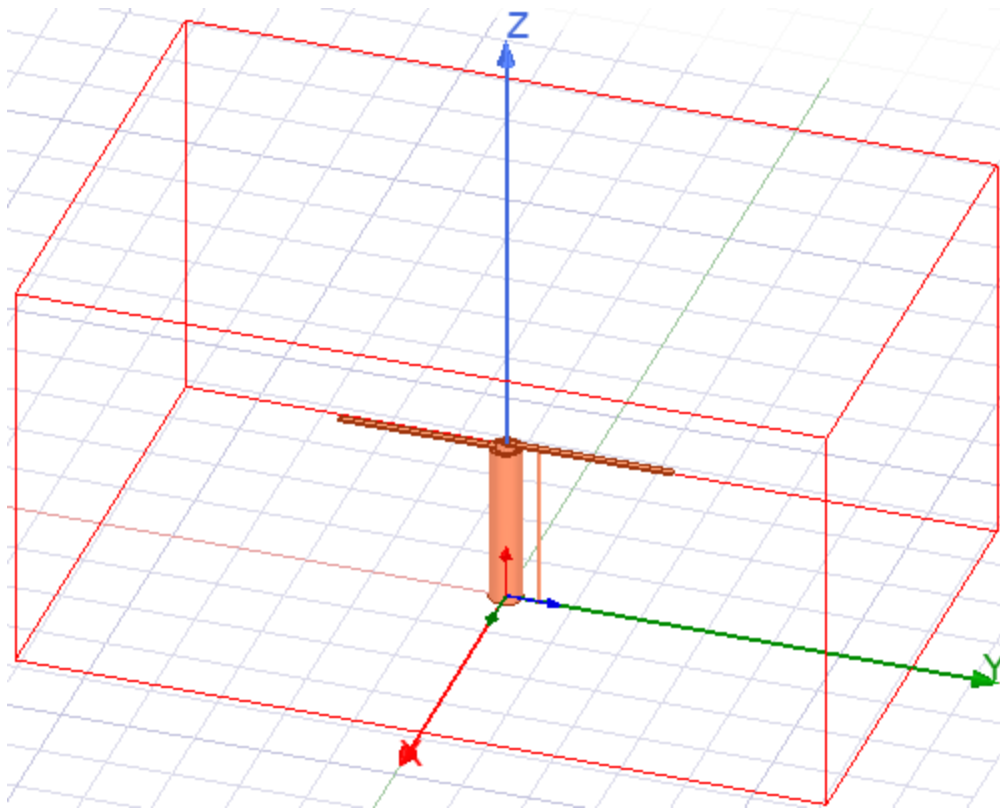

Figure 3-28: Open Region Created

Note:

The padding between the model and the radiation boundaries is 7.1582 inches, which is one-third the wavelength ($\lambda/3$) at the specified solution frequency of 0.55 GHz. You can verify the padding by selecting **CreateRegion** under *RadiatingSurface* in the History Tree.

Assign Excitation

You can now assign a wave port excitation to the previously drawn circle (*P1*).

1. Zoom in to more tightly enclose the bottom of the boom.
2. Under *Model > Sheets > Unassigned* in the History Tree, right-click **P1** and choose **Assign Excitation > Port > Terminal Wave Port** from the shortcut menu.
3. In the *Reference Conductors for Terminals* dialog box that appears, make the following changes:

- a. Type **P1** for the **Port Name**.
- b. Select the **Use as Reference** option for **Element_1**. (The other element should **not** be selected.)

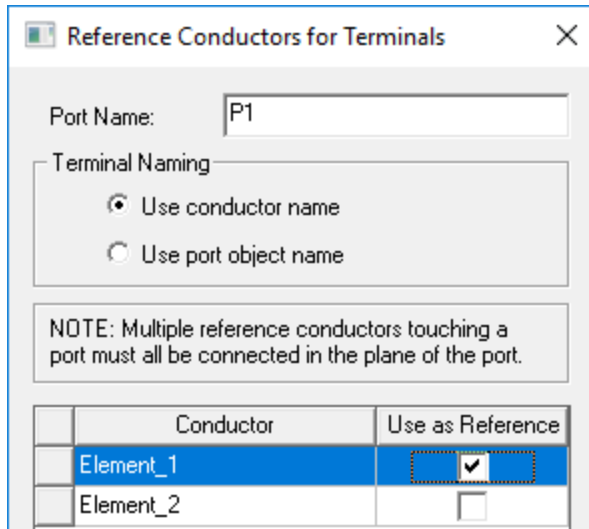

Figure 3-29: Specifying Reference Conductors for Terminals

4. Click **OK**.

P1 and its associated terminal (*Element_2_T1*) are listed under *Excitations* in the Project Manager:

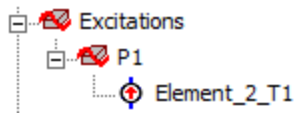

Figure 3-30: Excitation Defined

5. One at a time, select **P1** and then **Element_2_T1** in the Project Manager to see the wave port excitation and associated terminal visualized on the model:

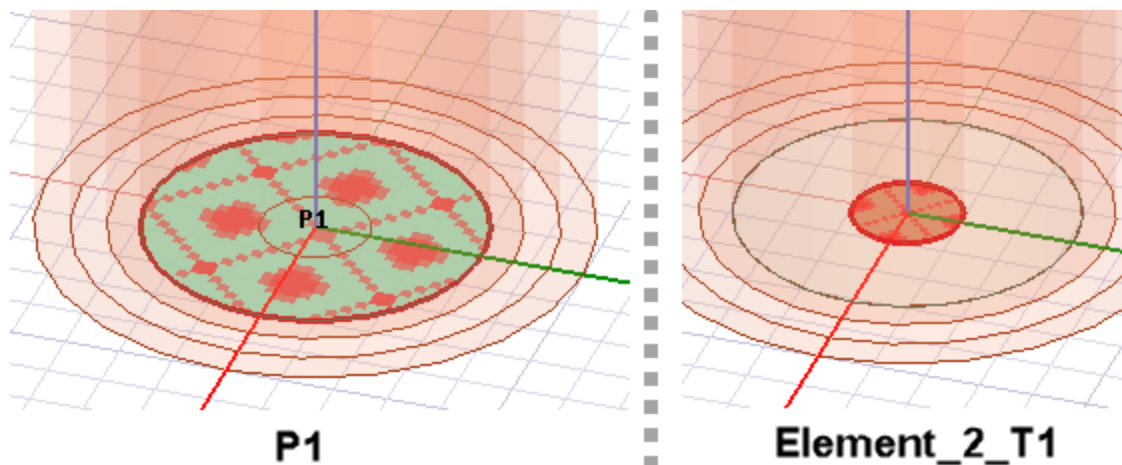

Figure 3-31: Wave Port Visualization

6. Double-click **Element_2_T1** to access the *Terminal* dialog box.
7. Shorten the **Terminal Name** to just **T1** and click **OK**.

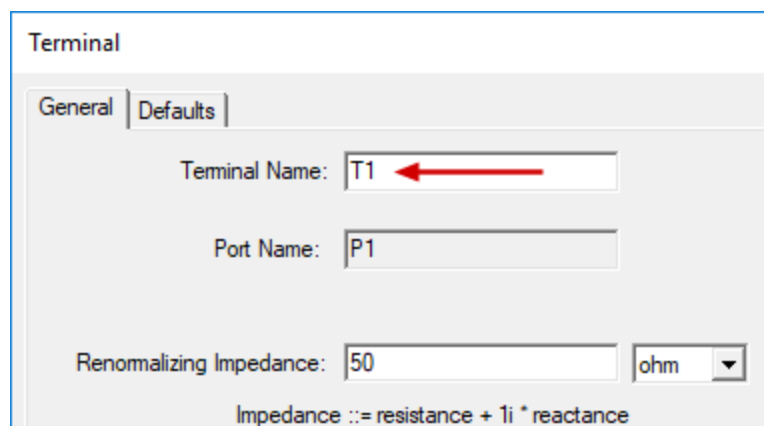

Figure 3-32: Renaming the Wave Port Terminal

8. Press **Ctrl+D** to fit the whole model to the viewing area and clear any selection.

Verify Radiation Setup

For the purpose of this exercise, the desired far field radiation sphere setup for post processing is as follows:

- **Phi:** Two values, 0° and 90°
- **Theta:** -180° through 180° in 1° increments (361 values)

This desired setup matches the *Elevation* far field setup, which was created automatically along with the open region. Verify the settings in the *Elevation* far field setup, as follows:

1. Under *Radiation* in the Project Manager, double-click **Elevation**.

The *Far Field Radiation Sphere Setup* dialog box appears.

2. Verify that the settings in the dialog box match the following figure:

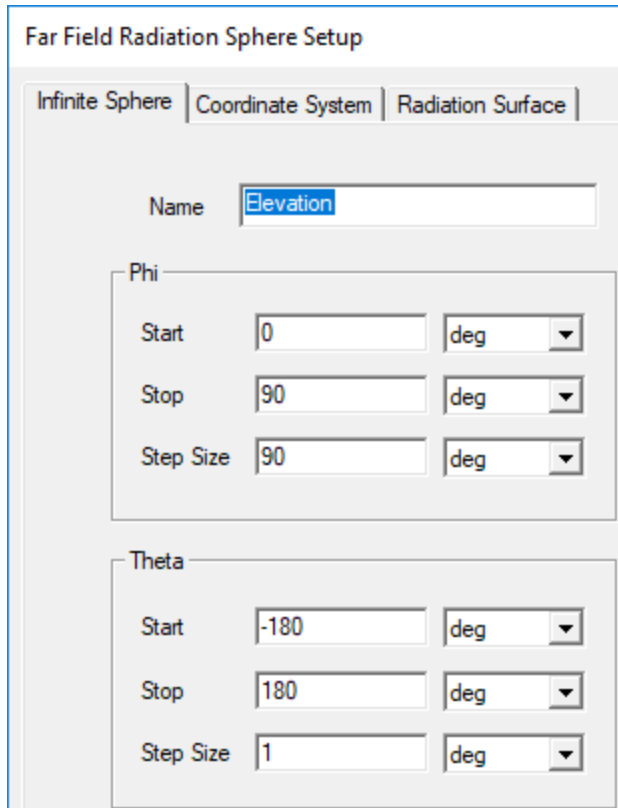

Figure 3-33: *Elevation* Far Field Radiation Sphere Setup

3. Click **OK**.

Refine Radiation Boundary Mesh

Far fields are calculated by integrating the fields on the radiation surface. To obtain accurate far field results for antenna problems, the mesh size (that is, the maximum tetrahedra length) on the integration surface should be in the range of $\lambda/6$ to $\lambda/8$.

To refine the mesh at the radiation boundary:

1. Under *Model* > *Solids* > *vacuum* in the History Tree, right-click **RadiatingSurface** and select **Assign Mesh Operation** > **On Selection** > **Length Based** from the shortcut menu.

The *Element Length Based Refinement* dialog box appears.

2. To the right of the selected **Set maximum element length** option, specify **3.5 in.**

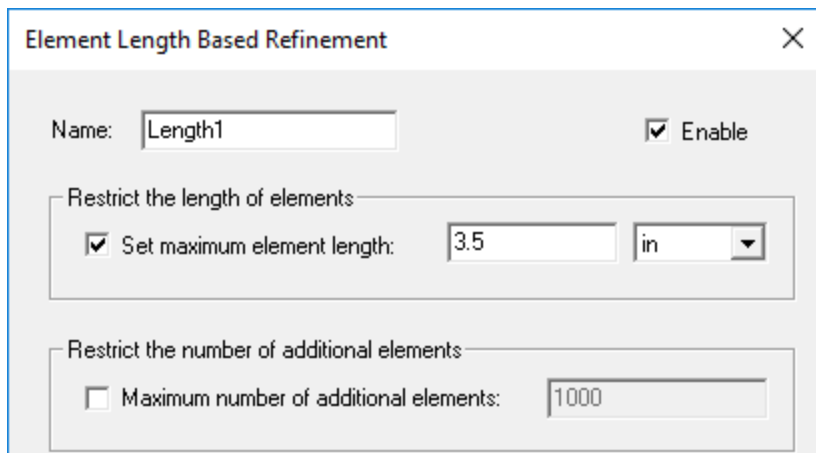



Figure 3-34: Element Length Based Refinement

Note:

This element length is slightly shorter than $\lambda/6$ at 0.55 GHz.

3. Click **OK**.
4. Clear the selection.
5.  **Save** the project.

4 - Analyze the Model

This chapter contains the following topics:

- Add Solution Setup
- Add Frequency Sweep
- Validate and Run Simulation
- View Solution Data
- Terminal S-Parameter vs. Frequency Plot
- Overlay Far Field Gain Plots

Add Solution Setup

1. On the **Simulation** ribbon tab, click  **Setup > Advanced**.

The *Driven Solution Setup* dialog box appears.

2. Under the **General** tab of the *Driven Solution Setup* dialog box, specify the settings shown in the following figure:

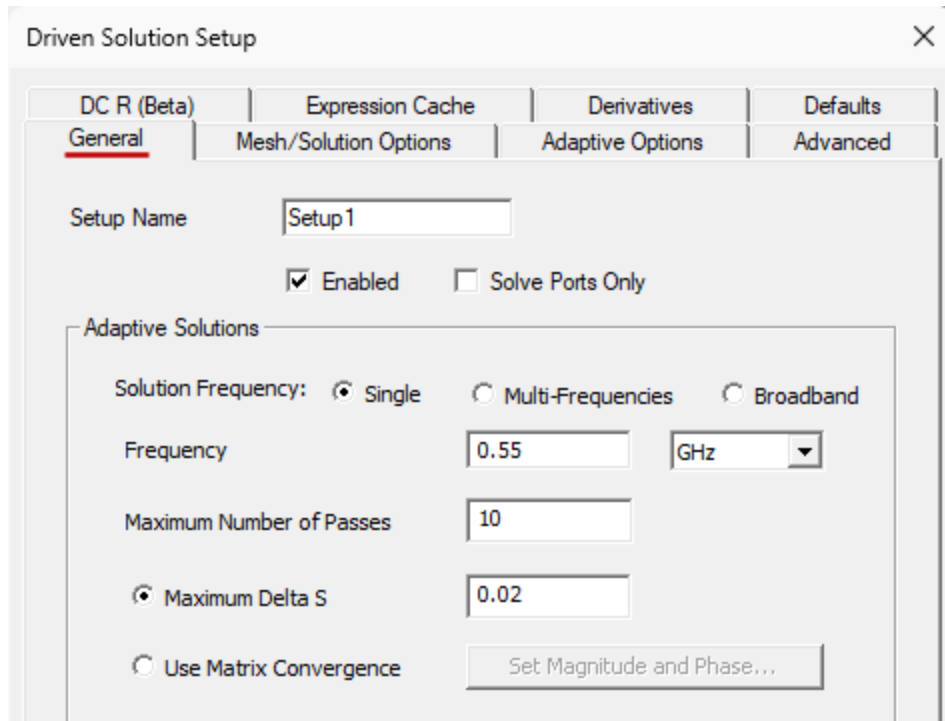

Figure 4-1: Driven Solution Setup – General Tab

3. Under the **Options** tab, in the *Solution Options* section, select the **Iterative Solver** option.
4. Click **OK**.

Because a port has already been assigned, the *Edit Frequency Sweep* dialog box opens automatically. Leave this dialog box open and proceed to the next topic, where you will define the sweep.

Add Frequency Sweep

When you add a solution setup to an HFSS design, and that design includes an assigned port excitation, the *Edit Frequency Sweep* dialog box appears automatically. This dialog box should already be open after you completed the previous procedure.

1. In the *Edit Frequency Sweep* dialog box, specify the settings shown in the following figure:

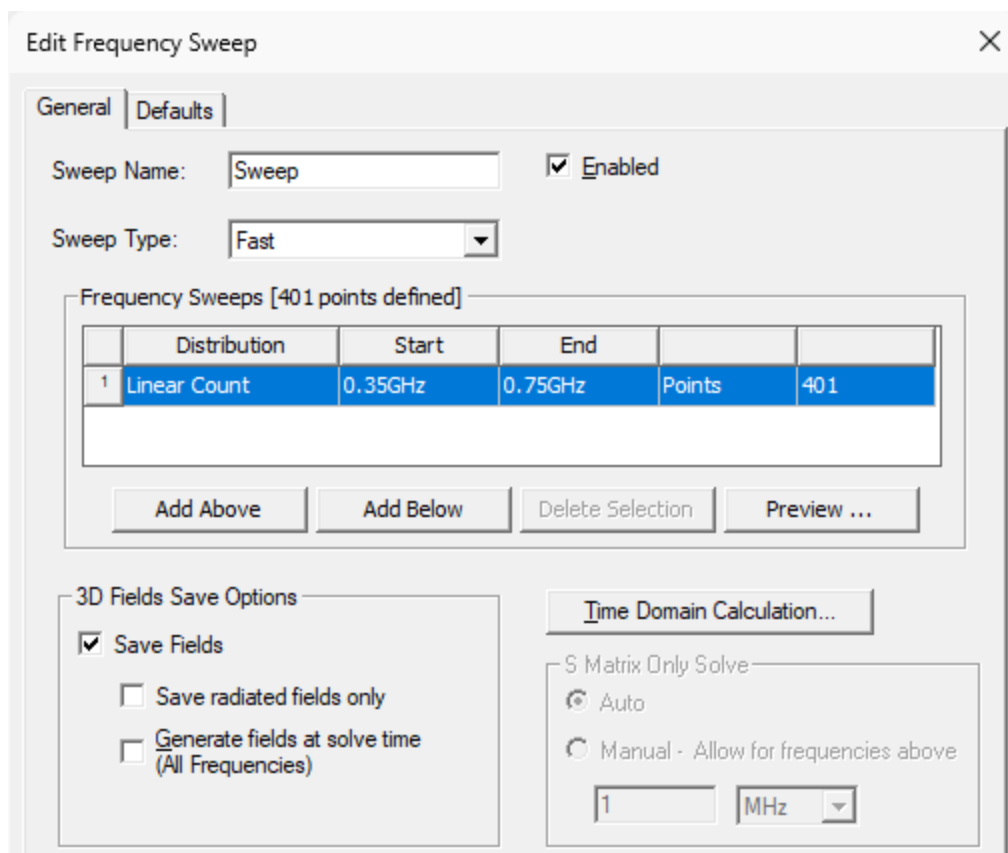



Figure 4-2: Frequency Sweep Settings

2. Click **OK**.

Validate and Run Simulation

Before you run the simulations, your design must pass the validation check.

1. On the Simulation ribbon tab, click  **Validate**.

The *Validation Check* dialog box appears.

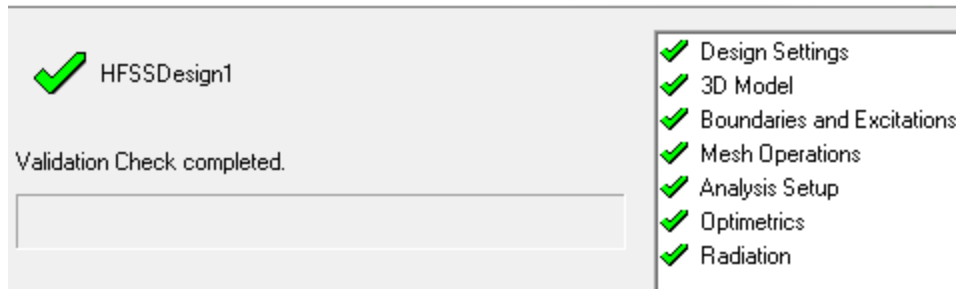

Figure 4-3: Validation Check

You should see no errors or warnings, and the model is ready to analyze.

2. Click **Close**.

3. On the **Simulation** ribbon tab, click  **Analyze All**.

The simulation should take less than ten minutes to solve on a reasonably current computer. While the solution is still progressing, you can continue to the next topic and review the solution data.

View Solution Data

You will now look at the solution profile, convergence, matrix data, and mesh statistics. If the solution is still progressing, more data will appear as it becomes available.

Keep in mind while viewing this information that you can resize the *Solution Data* dialog box by dragging its edges or corners. Also, you can adjust the width of individual columns in data tables by dragging the column head borders. Vertical and horizontal scroll bars are provided when the information overflows the dialog box size.

1. On the **Results** ribbon tab, click  **Solution Data**.

The *Solution Data* dialog box opens.

2. Select the **Profile** tab to view the solution profile.

Note:

This tab provides a synopsis of the simulation results ranging from information about the different adaptive passes; the matrix assembly for the S, Y, Z-parameters, etc.; and various other tasks that HFSS runs during the simulation. The profile also includes Real Time, CPU Time, and Memory consumed per task and the cumulative total times. The number of tetrahedra increases with each adaptive pass, improving the solution accuracy. You can alter the values of *Max Delta S* and *Maximum Number of Passes* in the solution setup and rerun HFSS to attain more accurate solutions, but be careful that you spend computational resources judiciously. You do not want the mesh to be too dense, nor too coarse. Therefore, for a good quality solution, use the default values as a guideline and modify them only as needed.

Task	Real Time	CPU Time	Memory	
Adaptive Meshing				Elapsed Time: 00:01:02
				Adaptive Passes converged
Frequency Sweep				Time: 11/01/2022 13:59:18
				HPC: Enabled
Solution Sweep				Fast Sweep
				From 0.35 GHz to 0.75 GHz, 400 Steps
Simulation Setup	00:00:01	00:00:01	149 M	Disk: 0 Bytes
Matrix Assembly	00:00:05	00:00:05	563 M	Tetrahedra: 44344, P1 Triangles: 89, Disk: 0 Bytes
Matrix Solve	00:01:17	00:04:19	1.12 G	Type: DCS-L2, Cores: 4, Matrix size: 293671, Matrix bandwidth: 21
Field Recovery	00:00:00	00:00:01	1.12 G	Excitations: 1, Disk: 10.5 MB
Frequency Sweep				Elapsed Time: 00:01:24
Simulation Summary				
Design Validation				Elapsed Time: 00:00:00, Total Memory: 88.5 MB
Initial Meshing				Elapsed Time: 00:00:13, Total Memory: 83.1 MB
Adaptive Meshing				Elapsed Time: 00:01:02, Average memory/process: 891 MB, Max r
Frequency Sweep				Elapsed Time: 00:01:24, Total Memory: 1.12 GB
				Max solved tets: 44344, Max matrix size: 293671, Matrix bandwidth
Solution Process				Elapsed Time: 00:02:41, ComEngine Memory: 135 M
				Stop Time: 11/01/2022 14:00:43, <u>Status: Normal Completion</u>

Figure 4-4: Solution Data – Profile Tab

3. Select the **Convergence** tab to view the solution convergence data.

Note:

You can view convergence history as a table or a graphical plot.

4. Select the **Plot** option.
5. Ensure that the following convergence plot settings are specified:
 - **X = Pass Number**
 - **Y = Max Mag. Delta S**

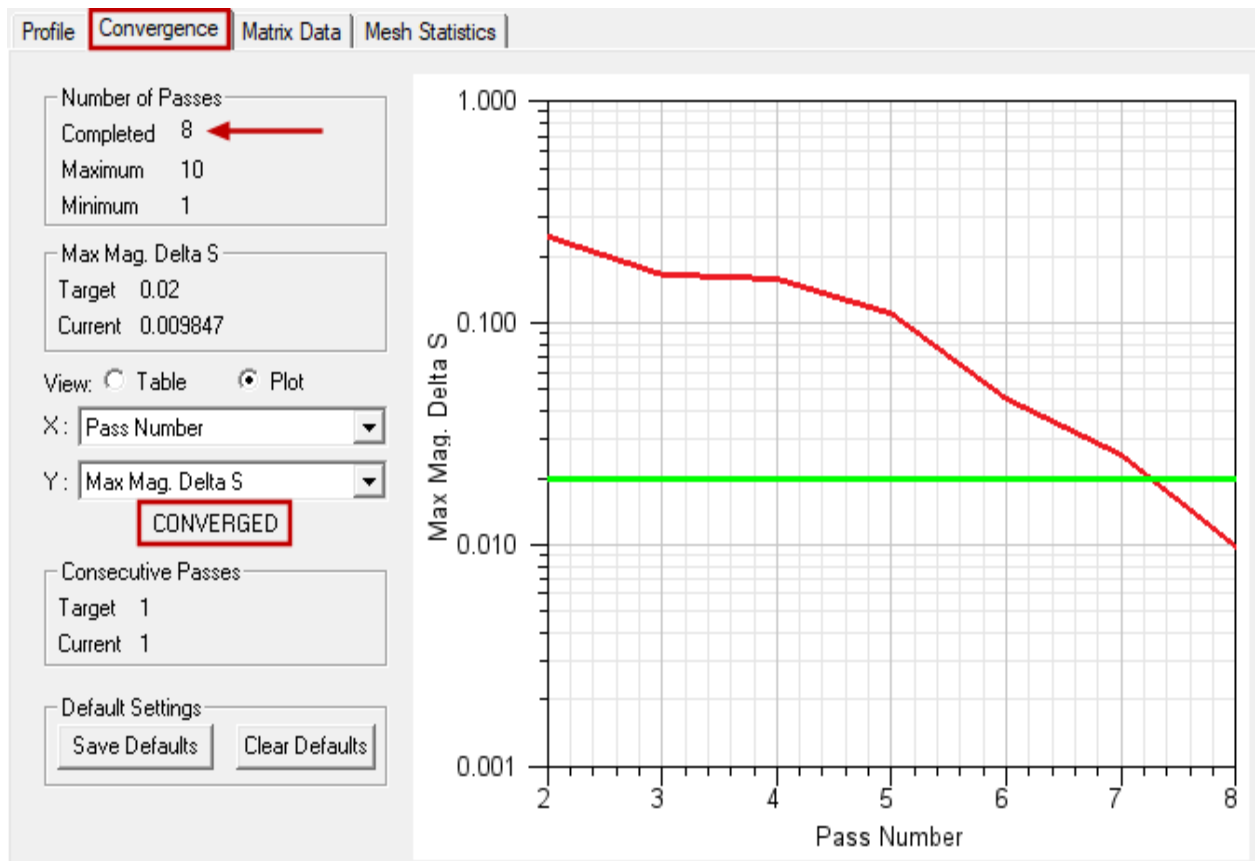

Figure 4-5: Solution Data – Convergence Tab (Plot)

Note:

At the 8th pass, the Maximum Delta S result satisfies the convergence criterion (Delta S Max = 0.02).

6. Select **Solved Elements** from the **Y** drop-down menu to display the total number of tetrahedral elements solved versus the pass number
7. Double click in the graph area to access the plot settings.
8. Under the **Y1 Scaling** tab, change the **Axis Scaling** value from *Log* to **Linear** and click **OK**:

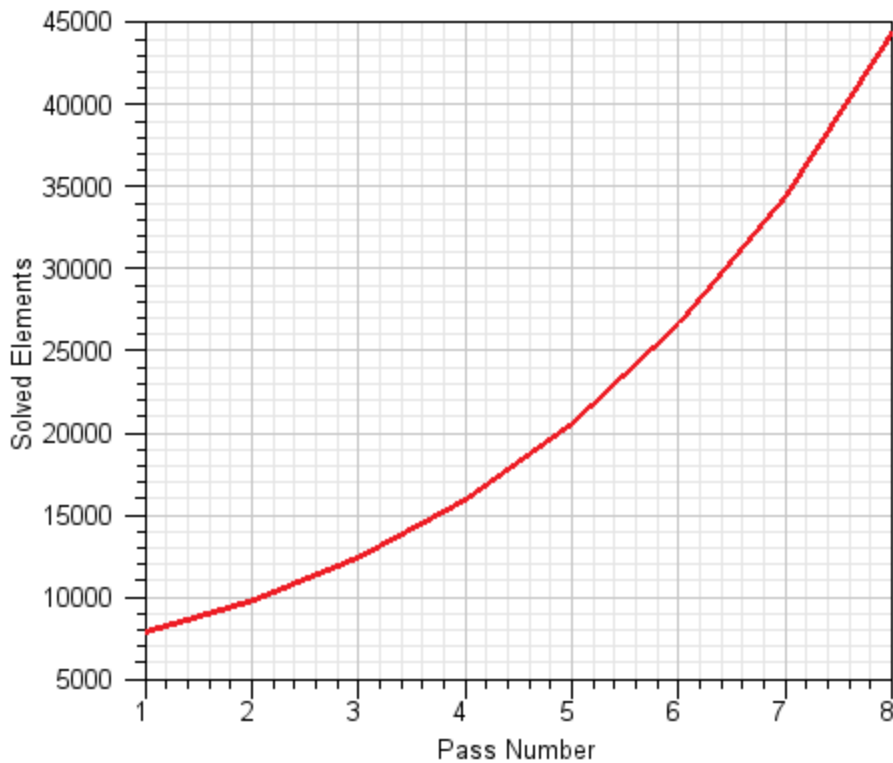

Figure 4-6: Total Tetrahedra Solved vs. Pass Number

9. Select the **Matrix Data** tab to see the matrix coefficients for selected frequencies or all frequencies.
10. Select all of the following options:
 - *Simulation: Setup1, Sweep1*
 - **Display All Frequencies**
 - **S Matrix**
 - **Y Matrix**
 - **Z Matrix**

Scroll through the listed frequencies. By default, the Magnitude and Phase Angle (in degrees) of the Terminal Data are listed for each coefficient and frequency. You can change these settings under the *Format* subtab.

Profile | Convergence | **Matrix Data** | Mesh Statistics

Display All Frequencies Edit Frequencies ...

S Matrix Y Matrix Z Matrix Gamma Zo

View Format Passivity Export

Freq	S:T1	Y:T1	Z:T1
740MHz	T1 (0.64237, 86.1)	(0.018794, -65.4)	(53.207, 65.4)
741MHz	T1 (0.64346, 85.5)	(0.018622, -65.5)	(53.699, 65.5)
742MHz	T1 (0.64455, 84.9)	(0.018452, -65.5)	(54.196, 65.5)
743MHz	T1 (0.64562, 84.4)	(0.018283, -65.6)	(54.696, 65.6)
744MHz	T1 (0.64667, 83.8)	(0.018115, -65.7)	(55.202, 65.7)
745MHz	T1 (0.64772, 83.2)	(0.01795, -65.7)	(55.711, 65.7)
746MHz	T1 (0.64875, 82.7)	(0.017786, -65.8)	(56.225, 65.8)
747MHz	T1 (0.64978, 82.1)	(0.017623, -65.8)	(56.744, 65.8)
748MHz	T1 (0.65079, 81.5)	(0.017462, -65.9)	(57.268, 65.9)
749MHz	T1 (0.65178, 81)	(0.017302, -65.9)	(57.796, 65.9)
750MHz	T1 (0.65277, 80.4)	(0.017144, -66)	(58.329, 66)

Figure 4-7: Solution Data – Matrix Data Tab (S, Y, and Z; All Frequencies)

Note:

To view a real-time update of the Matrix Data while the solution is still progressing, choose **Setup1** and **Last Adaptive** from the **Simulation** drop-down menus. Otherwise, choose *Sweep1* from the second drop-down menu to see the results at all frequencies in the specified sweep.

11. Select the **Mesh Statistics** tab to see the element count; minimum, maximum, and RMS edge lengths; minimum, maximum, and mean tetrahedra volumes; and the standard deviation of the element volume. These details are listed on a per part basis:

	Num Tets	Min edge length	Max edge length	RMS edge length	Min tet vol	Max tet vol	Mean tet vol	Std Devn (vol)
Element_1	3057	0.0649813	2.97247	0.515677	2.37054e-07	0.00616155	0.000532745	0.000561613
Element_2	3463	0.0478354	0.927997	0.228538	3.81297e-07	0.001537	8.18438e-05	0.000116837
RadiatingSurface	44344	0.0610156	4.32194	1.03893	2.79576e-07	2.92678	0.103458	0.274862

12. Click **Close**.

Terminal S-Parameter vs. Frequency Plot

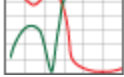
1. On the **Results** ribbon tab, click  **Terminal Solution Data Report** >  **2D**.
The *Report* dialog box appears.
2. Ensure that the settings are as shown in the following figure:

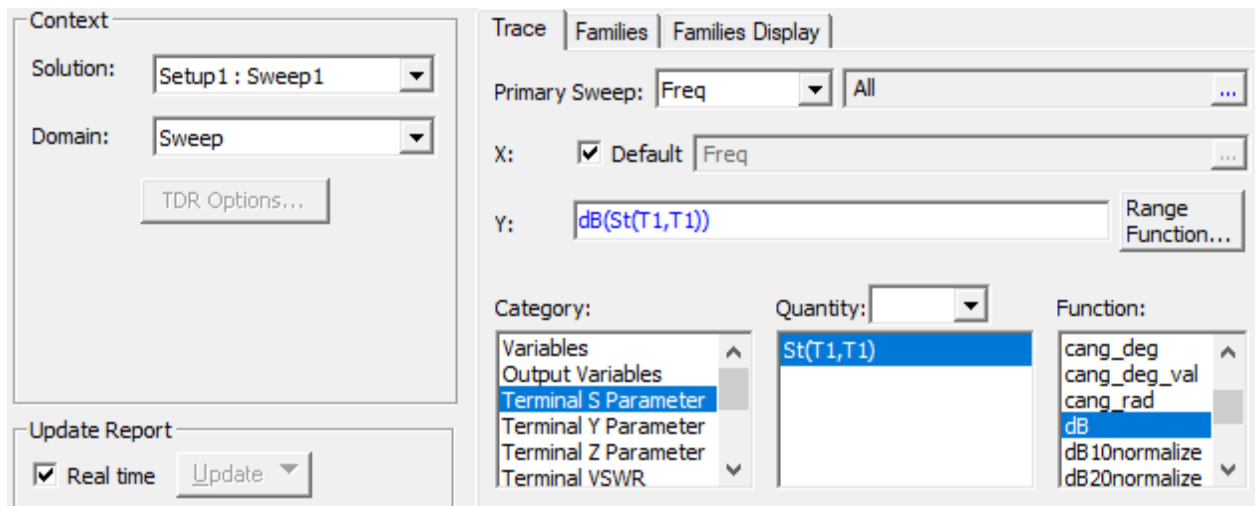

Figure 4-8: Terminal S-Parameter Plot Settings

3. Click **New Report** and click **Close**.
4. Click on the plot's X-axis to select it.

The x-axis settings appear in the docked *Properties* window.

5. In the **Axis** tab of the docked *Properties* window, make the following changes:
 - a. Change **Number Format** from *Auto* to **Decimal**.
 - b. Change **Field Precision** from 2 to **0** and press **Enter**.

Note:

You may need to scroll down to see the properties to edit.

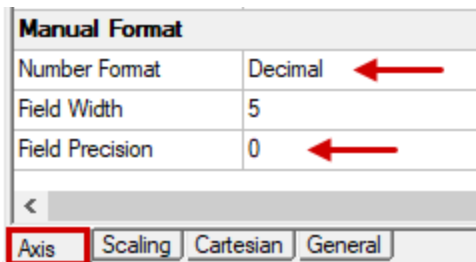

Figure 4-9: Plot X-Axis Properties

6. Click the red **trace** to select it. (The line weight increases to indicate that the trace is selected.)
7. Right-click in the *Plot 1* window and choose **Marker > Add Minimum** from the shortcut menu.

A marker and marker table are added to the plot. Point *m1* locates the resonant frequency of the UHF probe, which is the point of least signal reflection at the terminal.

8. Click in the plot background area (near the window border) to clear the trace selection.

The modified plot should resemble the following figure:

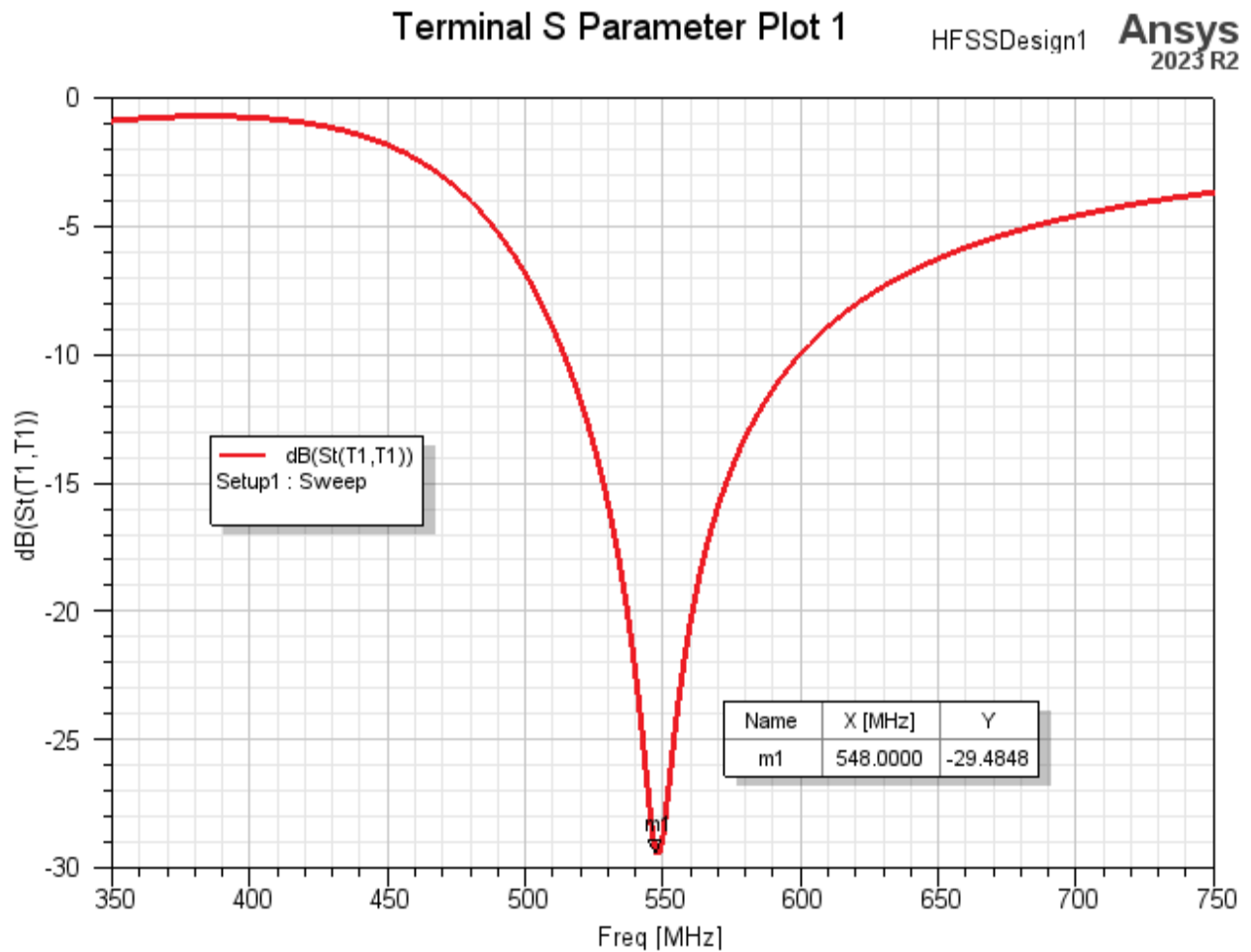



Figure 4-10: Terminal S-Parameter vs. Frequency Plot

Overlay Far Field Gain Plots

To evaluate the radiation pattern of the UHF probe, you will create two polar field plots, one showing the total gain for $\Phi = 0^\circ$, and one for $\Phi = 90^\circ$. Normally, you could apply both traces to a single plot. However, you will also overlay the gain plots on the model geometry, giving a clear picture of the radiation pattern in various directions. In order for a plot to be overlaid on the model geometry, it must contain a single Φ value. However, you can overlay multiple curves.

1. On the **Results** ribbon tab, click  **Far Fields Report >**  **Mag/Ang Polar**.
The *Report* dialog box appears.
2. Edit the settings as shown in the following figure:

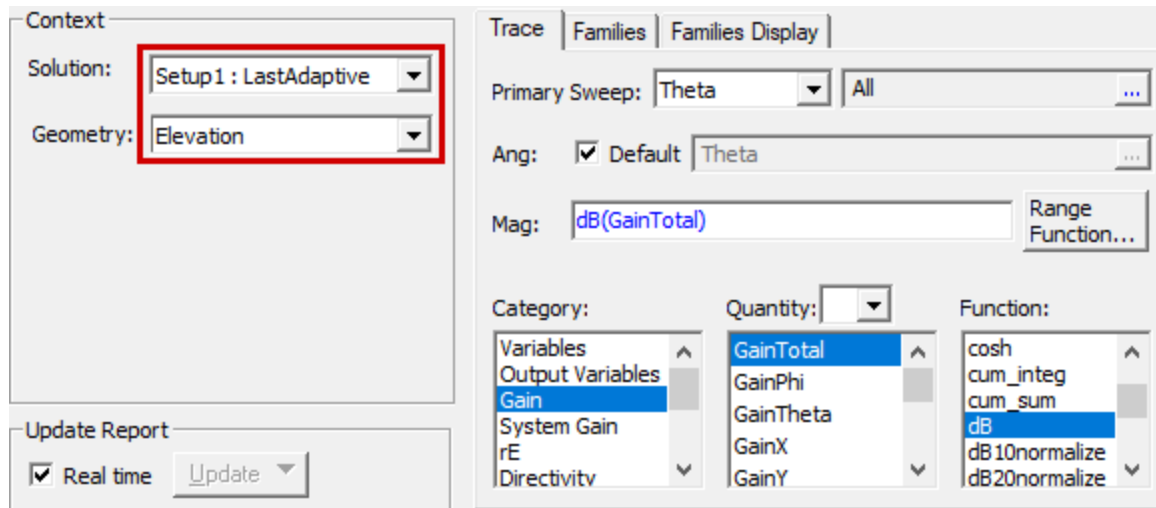

Figure 4-11: Gain Plot Settings – Trace Tab

- Under the **Families** tab, select the single value, **Phi = 0 deg**:

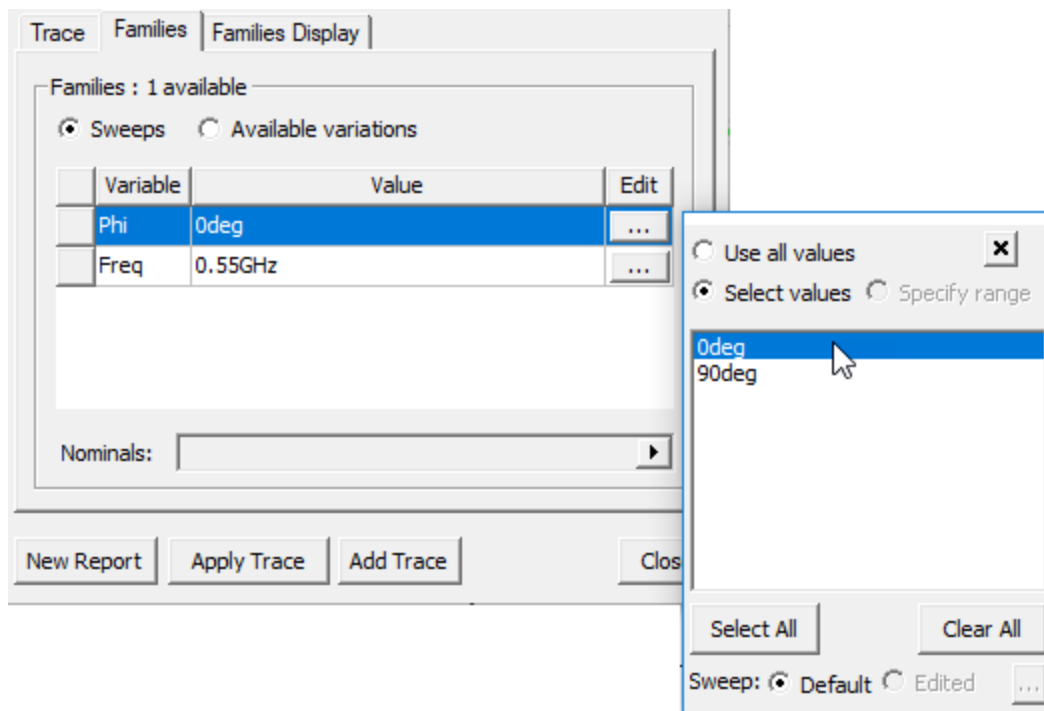

Figure 4-12: Gain Plot Settings – Families Tab

- Click **New Report** but keep the dialog box open.

Gain Plot 1 appears in a new window:

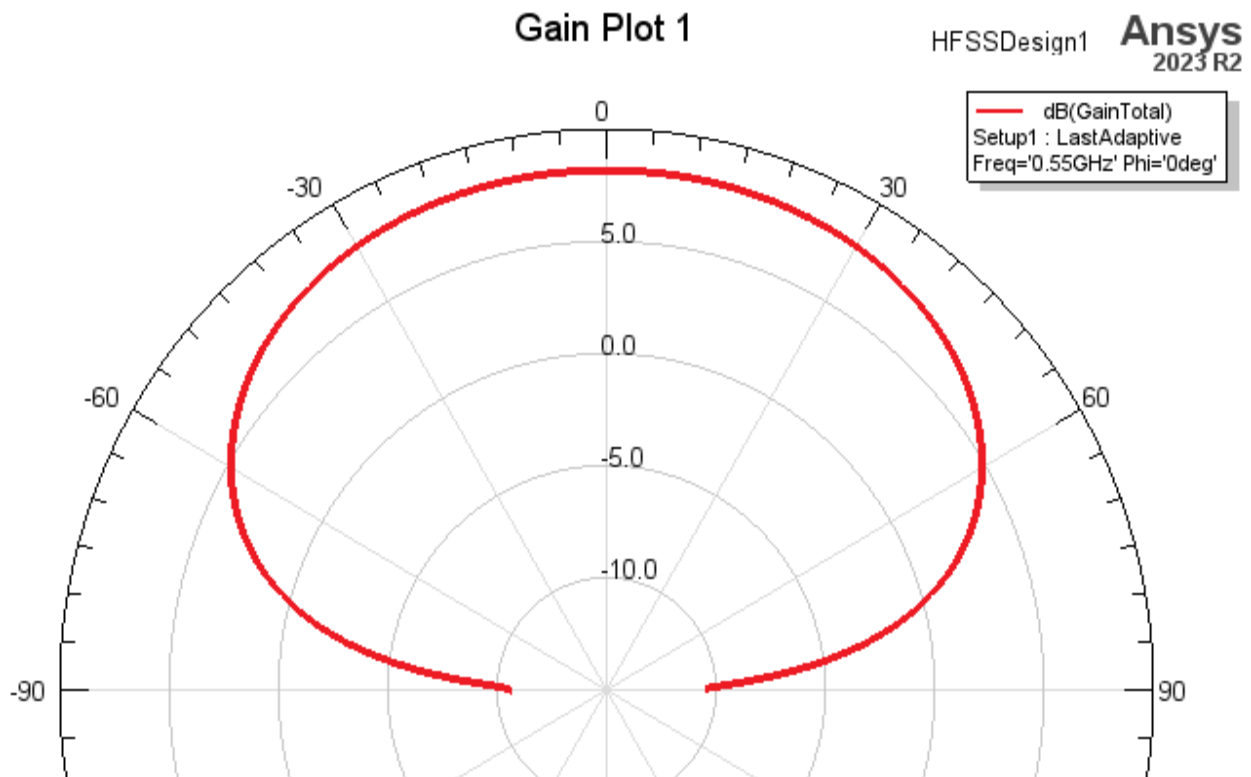

Figure 4-13: Gain Plot 1 (Phi = 0°)

5. Under the **Families** tab of the *Report* dialog box, select the single value, **Phi = 90 deg**.
6. Click **New Report** and click **Close**.

Gain Plot 2 appears in a new window.

To differentiate the appearance of the two gain plot curves, you will next change the color of the trace in *Gain Plot 2*.

7. Click the **trace** in *Gain Plot 2* to select it.
8. In the docked Properties window, change the **Color** value from **red** to **dark green** (column 3, row 4 of the *Basic colors*; Red: 0, Green: 128, Blue: 0) and click **OK**.

The modified plot should look like the following image:

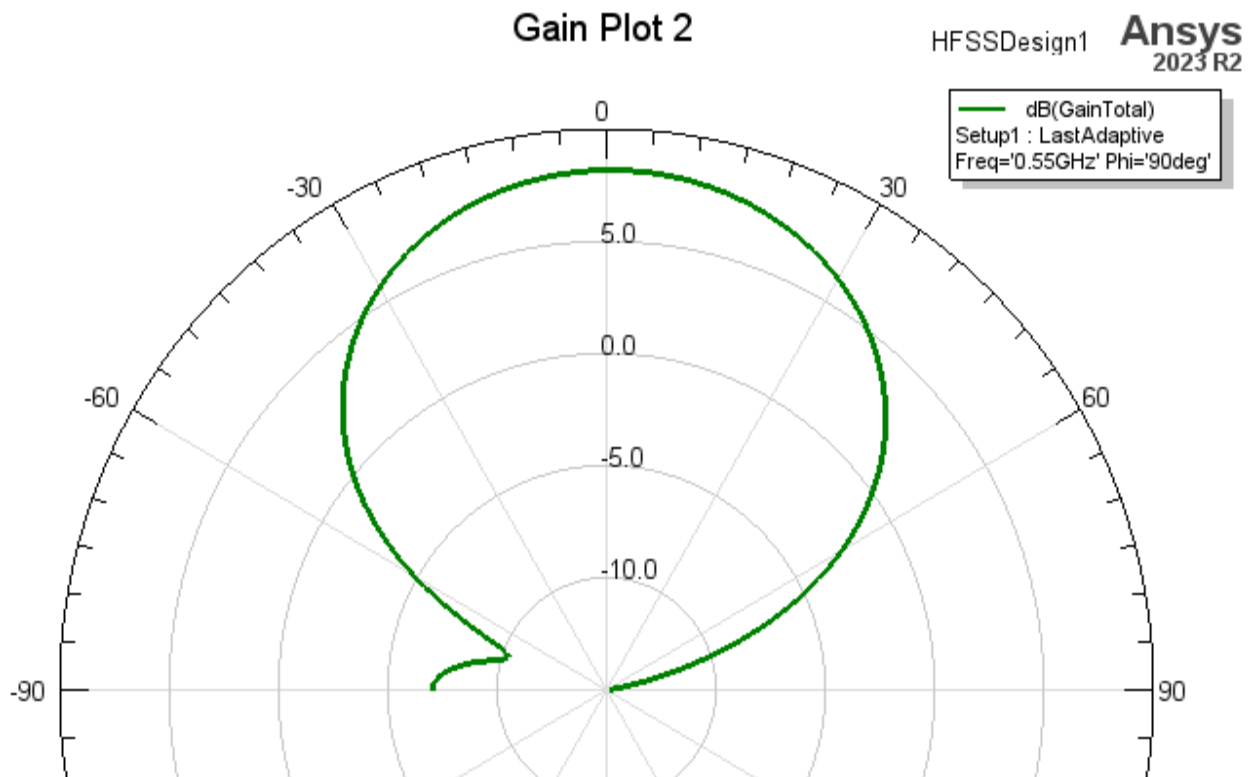

Figure 4-14: Gain Plot 2 (Phi = 90°)

9. Use the **Window** menu to bring the *Modeler* window to the foreground (**UHF_Probe - HFSSDesign1 - Modeler**).
10. Under *vacuum* in the History Tree, right-click **RadiatingSurface** and choose **View > Hide in Active View** from the shortcut menu.
11. Right-click in the *Modeler* window and choose **Plot Fields > Radiation Field**.
12. In the *Overlay Radiation Field* dialog box that appears, specify the following settings:

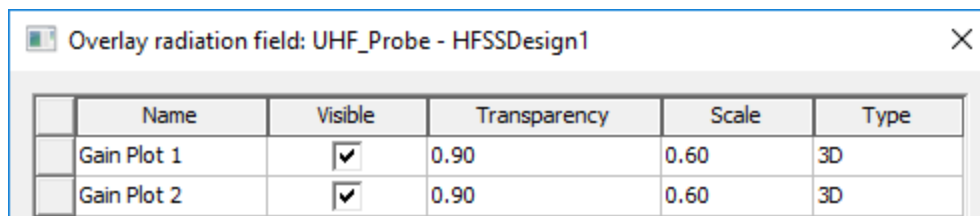

Figure 4-15: Radiation Field Overlay Settings

13. Click **Apply** and then click **Close**.
14. On the **Draw** ribbon tab, click **Orient > Isometric** for a better view of the overlays than provided by the default *Trimetric* view.

15. On the **Draw** ribbon tab, click  **Grid** to toggle off the drawing grid visibility.
16. Press **Ctrl+D** to fit the model and field plot overlays to the window.

The model and overlay should now resemble the following figure:

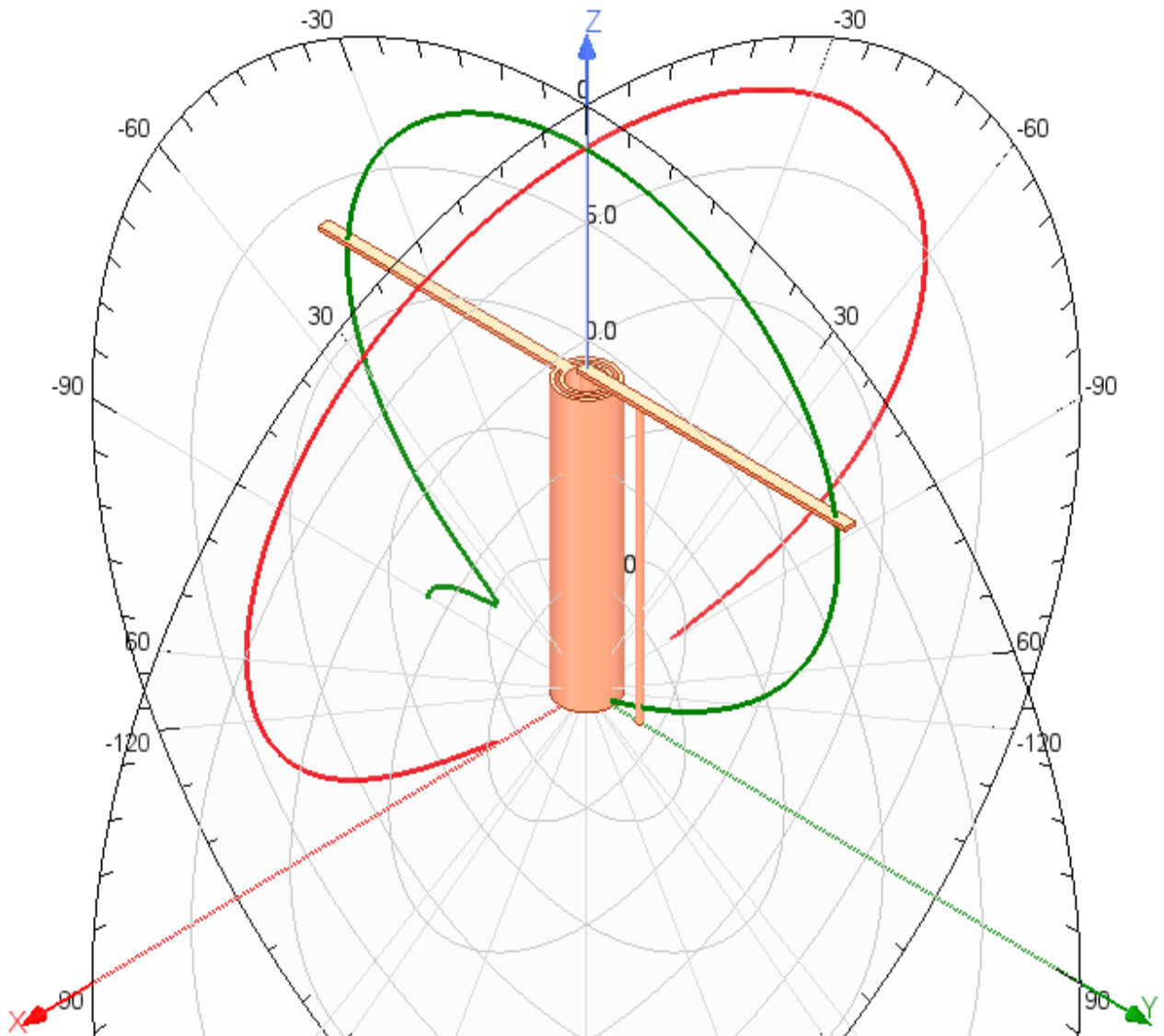

Figure 4-16: Radiation Field Overlay

Observations:

- Because the UHF probe is completely symmetrical about the YZ plane, the gain plot at $\Phi = 0^\circ$ (red curve) is also completely symmetrical.
- The UHF probe is asymmetrical about the XZ plane (due to the grounding pin and the slightly differing element elevations and lengths). Therefore, the gain plot at $\Phi = 90^\circ$ (green curve) is also asymmetrical.
- Because an infinite ground plane exists at the bottom of the boom, there are no radiation pattern results for $\Theta > 90^\circ$ or $\Theta < -90^\circ$.

17.  **Save** the project.

5 - Optionally, Restore Current View Orientations

You have completed this getting started guide.

If you prefer to use the new view orientations implemented in version 2024 R1 of the Ansys Electronics Desktop application, clear the *Use Legacy View Orientation* option as follows:

1. From the menu bar, click **View > Options**.
The *3D UI Options* dialog box appears.
2. Ensure that **Enable Legacy View Orientation** is cleared:

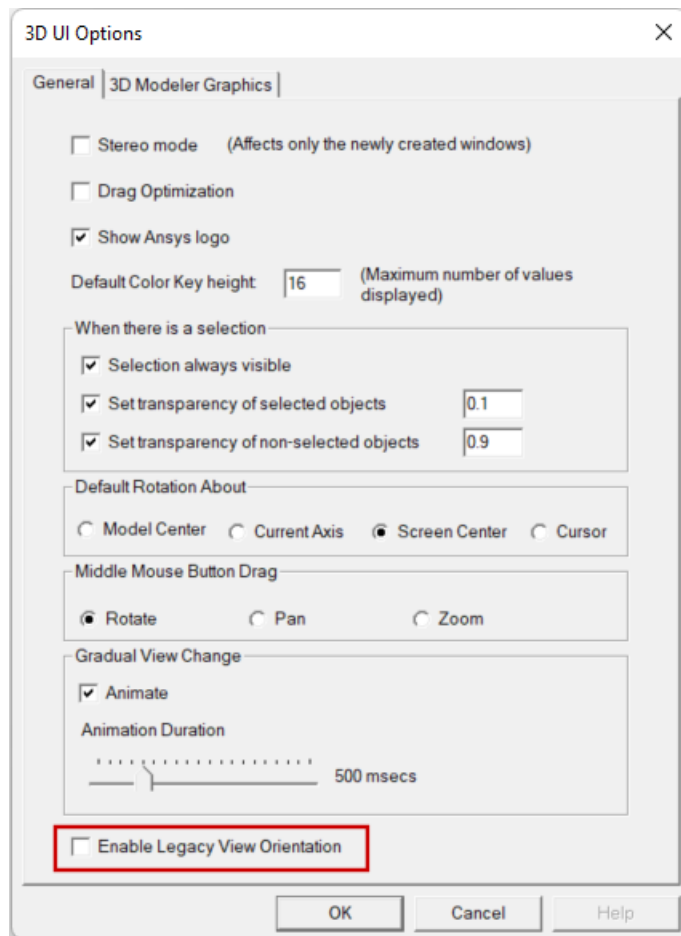

3. Click **OK**.

The settings in the 3D UI Options dialog box are global. Your choice is retained for all future program sessions, projects, and design types that use the 3D Modeler or that produce 3D plots of results.

You can now save and close this project.